

PULSAR[®] R80 RADAR

Installation and Operating Manual for Pulsar[®] Model R80 with HART[®] output

*High Performance 80 GHz FMCW
Radar Level Transmitter*

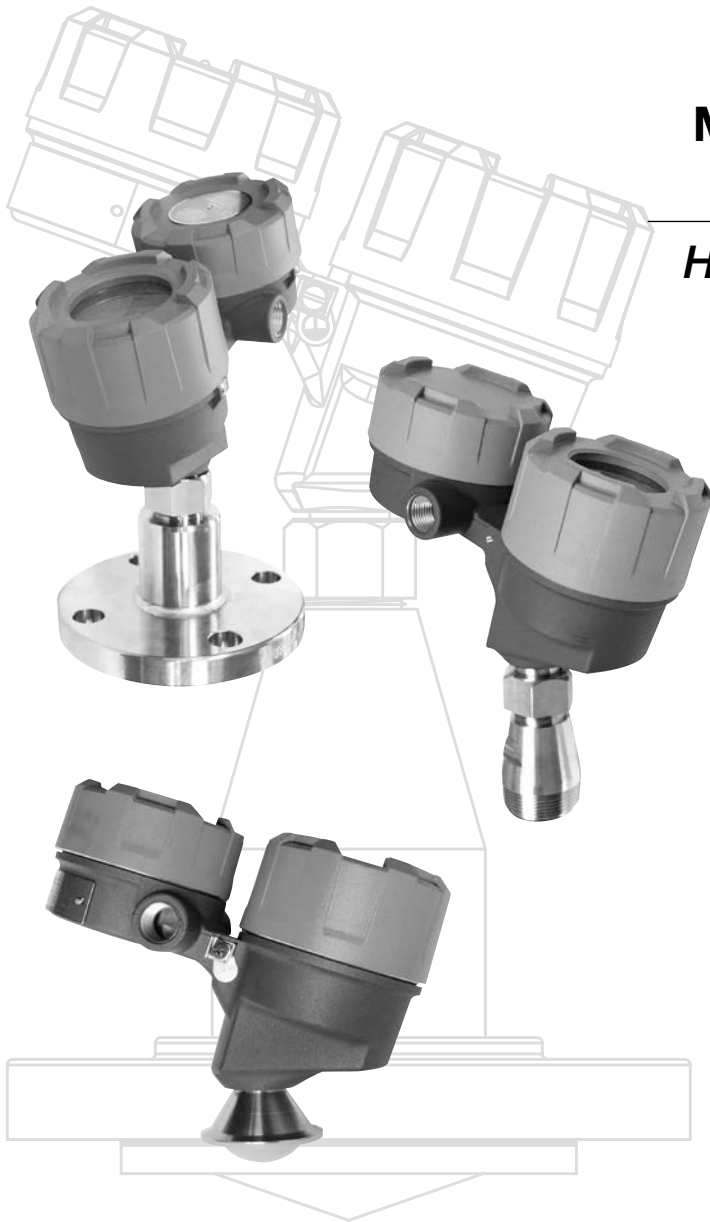

MAGNETROL[®]

AMETEK[®]

LEVEL MEASUREMENT
SOLUTIONS

Read this Manual Before Installing

This manual provides information on the Pulsar® Model R80 Radar transmitter. It is important that all instructions are read carefully and followed in sequence. The *QuickStart Installation* instructions are a brief guide to the sequence of steps for experienced technicians to follow when installing the equipment. Detailed instructions are included in the *Complete Installation* section of this manual.

Conventions Used in this Manual

Certain conventions are used in this manual to convey specific types of information. General technical material, support data, and safety information are presented in narrative form. The following styles are used for notes, cautions, and warnings.

NOTES

Notes contain information that augments or clarifies an operating step. Notes do not normally contain actions. They follow the procedural steps to which they refer.

Cautions

Cautions alert the technician to special conditions that could injure personnel, damage equipment, or reduce a component's mechanical integrity. Cautions are also used to alert the technician to unsafe practices or the need for special protective equipment or specific materials. In this manual, a caution box indicates a potentially hazardous situation which, if not avoided, may result in minor or moderate injury.

WARNINGS

Warnings identify potentially dangerous situations or serious hazards. In this manual, a warning indicates an imminently hazardous situation which, if not avoided, could result in serious injury or death.

Safety Messages

The Pulsar Model R80 system is designed for use in Category II, Pollution Degree 3 installations. Follow all standard industry procedures for servicing electrical and computer equipment when working with or around high voltage. Always shut off the power supply before touching any components. Although high voltage is not present in this system, it may be present in other systems.

Electrical components are sensitive to electrostatic discharge. To prevent equipment damage, observe safety procedures when working with electrostatic sensitive components.

This device complies with Part 15 of the FCC rules. Operation is subject to the following two conditions: (1) This device may not cause harmful interference, and (2) This device must accept any interference received, including interference that may cause undesired operation.

Low Voltage Directive

For use in Installations Category II, Pollution Degree 3. If equipment is used in a manner not specified by the manufacturer, protection provided by equipment may be impaired.

Warranty

All AMETEK LMS electronic level and flow controls are warranted free of defects in materials or workmanship for eighteen months from the date of original factory shipment.

If returned within the warranty period; and, upon factory inspection of the control, the cause of the claim is determined to be covered under the warranty; then, AMETEK LMS will repair or replace the control at no cost to the purchaser (or owner) other than transportation.

AMETEK LMS shall not be liable for misapplication, labor claims, direct or consequential damage or expense arising from the installation or use of equipment. There are no other warranties expressed or implied, except special written warranties covering some AMETEK LMS products.

Quality Assurance

The quality assurance system in place at AMETEK LMS guarantees the highest level of quality throughout the company. AMETEK LMS is committed to providing full customer satisfaction both in quality products and quality service.

The AMETEK LMS quality assurance system is registered to ISO 9001 affirming its commitment to known international quality standards providing the strongest assurance of product/service quality available.

Copyright © 2022 AMETEK Magnetrol USA, LLC

Performance specifications are effective with date of issue and are subject to change without notice. AMETEK LMS reserves the right to make changes to the product described in this manual at any time without notice. AMETEK LMS makes no warranty with respect to the accuracy of the information in this manual.

Pulsar® Model R80

80 GHz FMCW Radar Level Transmitter

Table of Contents

1.0 QuickStart Installation	
1.1 Getting Started	5
1.1.1 Equipment and Tools	5
1.1.2 Configuration Information	6
1.2 QuickStart Mounting	7
1.2.1 Antenna	7
1.2.2 Transmitter	7
1.3 QuickStart Wiring	8
1.4 Serup Wizard – Configuration	8
1.4.1 Setup Wizard Menu Options	10
1.4.1.1 Setup Wizard Numerical Data Entry	11
2.0 Complete Installation	
2.1 Unpacking	12
2.2 Electronic Discharge (ESD) Handling Procedure	12
2.3 Before You Begin	13
2.3.1 Site Preparation	13
2.3.2 Equipment and Tools	13
2.3.3 Operational Considerations	13
2.3.3.1 Maximum Distance	14
2.3.3.2 Minimum Distance	14
2.3.3.3 Problematic Applications; GWR Alternative	14
2.4 Mounting	15
2.4.1 Installing the Antenna	15
2.4.1.1 Location	15
2.4.1.2 Beam Angle	15
2.4.1.3 Obstructions	16
2.4.1.4 Nozzles	16
2.4.1.5 Standpipes and Stillwells	16
2.4.2 Installing the Transmitter	16
2.4.2.1 Low Echo Margin	17
2.5 Wiring	18
2.5.1 General Purpose or Division 2	18
2.5.2 Intrinsically Safe	19
2.5.3 Explosion Proof	19
2.6 Configuring the Transmitter	20
2.6.1 Bench Configuration	20
2.6.2 Menu Traversal and Data Entry	21
2.6.2.1 Navigating the Menu	21
2.6.2.2 Data Selection	21
2.6.2.3 Entering Numeric Data Using Digit Entry	22
2.6.2.4 Entering Numeric Data Using Increment/Decrement	22
2.6.2.5 Entering Character Data	23
2.6.3 Password Protection	23
2.6.4 Menu: Step-By-Step Procedure	24
2.6.5 Configuration Menu: Device Setup	27
2.7 Configuration Using HART®	31
2.7.1 Connections	31
2.7.2 Display Menu	31
2.7.3 Model R80 HART Revision Table	31
2.7.4 HART Menu	32
3.0 Reference Information	
3.1 Description	34
3.2 Theory of Operation	34
3.2.1 FMCW Radar	34
3.3 Configuration Information	35
3.3.1 Bottom Blocking Distance Description	35
3.3.2 Reset Function	36
3.3.3 Echo Rejection	37
3.3.4 Volumetric Capability	37
3.3.4.1 Configuration Using Built-in Vessel Types	37
3.3.4.2 Configuration Using Custom Table	39
3.3.5 Open Channel Flow Capability	40
3.3.5.1 Configuration using Flume/Weir Equations	41
3.3.5.2 Configuration using Generic Equation	42
3.3.5.3 Configuration using Custom Table	43

3.4	Troubleshooting and Diagnostics	44
3.4.1	Diagnostics (Namur NE 107)	44
3.4.2	Diagnostic Indication Simulation	46
3.4.3	Diagnostic Help	46
3.4.4	Diagnostic Indicator Table	48
3.4.5	Additional Diagnostic/Trouble Shooting Capabilities.	50
3.4.5.1	Echo History Setup	50
3.4.5.2	Event History	50
3.4.5.3	Context-sensitive Help	50
3.4.5.4	Trend Data	50
3.5	Agency Approvals	51
3.5.1	Agency Drawing & Entity Parameters	54
3.6	Specifications	55
3.6.1	Functional – Transmitter	55
3.6.2	Functional – Environmental	55
3.6.3	Performance	56
3.6.3.1	Safe Operating Areas	56
3.6.3.2	Transmitter Terminal Voltage	56
3.6.4	O-ring (seal) Selection Chart	57
3.6.5	Functional – Antenna	57
3.6.6	Antenna Pressure/Temperature Ratings	57
3.6.7	Operating Temperature Range.	58
3.6.8	Physical	58
3.7	Replacement Parts	59
3.8	Model Numbers.	60
3.8.1	Pulsar Model R80 Radar Transmitter.	60
3.8.2	Pulsar Model R80 Radar Antennas	61

**4.0 Advanced Configuration/Troubleshooting
Techniques**

4.1	Echo Rejection	62
4.2	Custom Echo Rejection.	66
4.3	Tank Profile	71
4.4	Echo Margin	73
4.5	Automated Echo Capture	74
4.6	Event History	75

1.0 QuickStart Installation

The QuickStart Installation procedures provide an overview of the key steps for mounting, wiring, and configuring the Pulsar Model R80 radar level transmitter. These procedures are intended for experienced installers of electronic level measurement instruments.

See Section 2.0, Complete Installation, for detailed installation instructions.

1.1 Getting Started

Before beginning the QuickStart Installation procedures, have the correct equipment, tools, and information available.

1.1.1 Equipment and Tools

No special tools are required. The following items are recommended:

- Threaded antenna and process connection adjustable wrench
- Transmitter/antenna connection. . . . adjustable wrench
- Torque wrench highly desirable
- Flat-blade screwdriver
- Digital multimeter or volt/ammeter optional

1.1.2 Configuration Information

A helpful SETUP WIZARD, which will guide you through the simple configuration (with parameter explanations), is available in the Pulsar Model R80. Located in the local user interface menu under MAIN MENU/WIZARDS/SETUP WIZARD, some key information is required for configuration. The transmitter will prompt confirmation questions at the end of the Setup Wizard to verify operation.

Gather the information and complete the following operating parameters table before beginning configuration.

NOTE: These configuration steps are not necessary if the transmitter was pre-configured prior to shipment.

Display	Question	Answer
Measurement Type	What is the intended measurement type (Level, Volume, or Flow)?	
System Units	What units of measurement will be used?	
Antenna Model	What type of antenna is being used? Select first 3 digits of model number. (See nameplate on side of antenna.)	
Antenna Mount	Is the antenna mounting NPT, BSP, or flanged?	
Tank Height	What is the tank height?	
Stillwell ID	What is the Inner Diameter (ID). Enter 0 if not applicable.	
Dielectric Range	What is the dielectric of the process medium?	
Turbulence	What amount of turbulence is expected?	
Foam	What amount of foam is expected?	
Rate of Change	What is the expected maximum rate of level change?	
Primary Variable	Select Level, Volume, or Flow	
4 mA Setpoint (LRV)	What is the 0% reference point for the 4.0 mA value?	
20 mA Setpoint (URV)	What is the 100% reference point for the 20.0 mA value?	
PV Alarm Selection	What output current is desired when a failure indicator is present?	
Damping	How much damping (averaging) is required? Default = 1 second	

1.2 QuickStart Mounting

NOTE: Confirm the configuration style and process connection (size and type) of the Pulsar Model R80 radar transmitter. Ensure it matches the requirements of the installation before continuing with the QuickStart installation.

- ① Confirm the model and serial numbers on the nameplates of Pulsar Model R80 electronics and antenna are identical.

1.2.1 Antenna

- ② Carefully place the antenna into the vessel. Ideally, mount in a location equal to $\frac{1}{2}$ the radius of tank top. Do not mount in center of vessel nor closer than 30 cm (12") of tank wall.
- ③ Secure the antenna to the vessel.
- ④ Leave the protective plastic cap in place until ready to install the transmitter.

NOTE: Do not use sealing compound or TFE tape on antenna connection to transmitter. This connection is sealed by a Viton® O-ring.

1.2.2 Transmitter

1. Remove the protective plastic cap from the top of the antenna and Universal Connector (store for future use). Make sure the bottom of the Universal connector and inside of the antenna are clean and dry. Clean with isopropyl alcohol and cotton swabs if necessary.
2. Place the transmitter onto the antenna.
3. Rotate the transmitter so that it is in the most convenient position for wiring, configuring, and viewing.
4. While keeping the housing aligned, tighten the large Universal connector Hex nut to 40 Nm (30 ft./lbs) of force. A torque wrench is highly desirable.

DO NOT LEAVE HAND TIGHT.

- Do not place insulating material around any part of the Radar transmitter including the antenna flange.

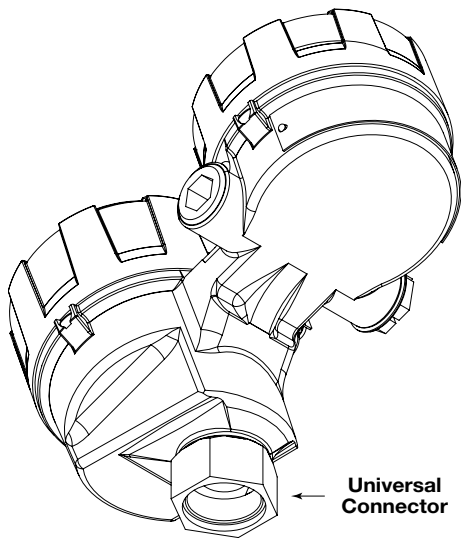

1.3 QuickStart Wiring

WARNING! Explosion hazard. Do not remove covers unless power has been switched off or the area is known to be non-hazardous.

NOTE: Ensure that the electrical wiring to the Pulsar Model R80 radar transmitter is complete and in compliance with all regulations and codes.

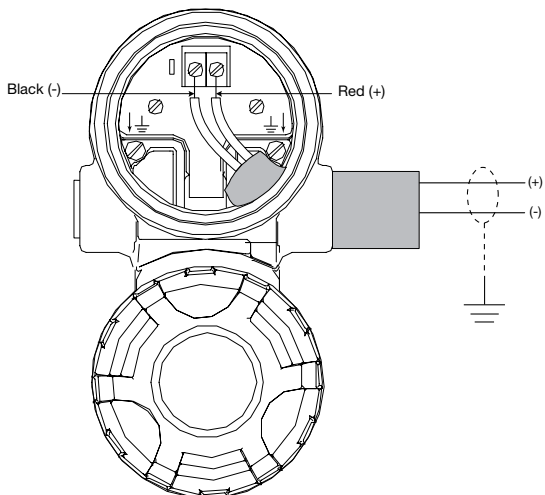

1. Remove the cover of the upper wiring compartment.
2. Attach a conduit fitting and mount the conduit plug in the spare opening. Pull the power supply wire through the conduit fitting.
3. If present, connect cable shield to an earth ground at the power supply.
4. Connect the positive supply wire to the (+) terminal and the negative supply wire to the (-) terminal. For Explosion Proof Installations, see *Wiring*, Section 2.5.3.
5. Replace the cover and tighten.

1.4 Setup Wizard – Configuration

If requested, the Pulsar Model R80 transmitter is shipped fully pre-configured for the application and can be installed immediately. Otherwise, the unit is shipped configured with default factory values and can be easily reconfigured in the shop. The minimum configuration instructions follow. Use the information from the operating parameters table before beginning configuration. See Section 1.1.2, *Configuration Information*.

The Setup Wizard offers a very simple step-by-step menu indicating the basic parameters required for a typical application.

1. Apply power to the transmitter.

The graphic LCD display can be programmed to change every two seconds to show pertinent Measured Values on the Home Screen. For example: Level, %Output, and Loop current can all be displayed on a rotating screen.

The LCD can also be programmed to always show just one of the Measured Variables at all times. For example: Level can be the only value displayed on the screen.

2. Remove the cover of the electronics compartment.



Up Down Back Enter

STEP 4



Up Down Back Enter

STEP 5



STEP 6



3. The push buttons offer multiple forms of functionality for menu navigation and data entry. (See Section 2.6 for complete explanation.)

↑ **UP** moves up through the menu or increases a displayed value.

↓ **DOWN** moves down through the menu or decreases a displayed value.

↶ **BACK** exits a branch of the menu or exits without accepting entered value.

↵ **ENTER** enters a branch of the menu or accepts a displayed entry.

NOTE: Holding down the ENTER key for two seconds when any menu or parameter is highlighted will show help text in reference to that item.

4. Press any key at the Home Screen to access the Main Menu.

5. Press ↵ ENTER with the WIZARDS menu item highlighted.

6. Press ↵ ENTER with the SETUP WIZARD menu item highlighted.

The Setup Wizard shows the basic parameters, along with Help Text to guide the procedure.

One can now quickly and easily scroll through the Setup Wizard configuration items, changing those parameters as required:

- Press ↵ ENTER at the highlighted parameter.
- Scroll to the desired option, then press ↵ ENTER.
- Scroll to next parameter or press ↶ BACK when finished to exit the WIZARDS menu.

Section 1.4.1 lists and describes the nine parameters in the SETUP WIZARD menu.

7. After making all of the necessary changes in the WIZARDS menu, press the ↶ BACK button three times to return to the Home Screen.

8. The QuickStart configuration is complete. The Model R80 transmitter should be measuring level and ready for service.

1.4.1 Setup Wizard Menu Options

Level Units	Select the Units of measurement for the level output: <ul style="list-style-type: none"> • Inches • Feet • Millimeters • Centimeters • Meters 	
Tank Height	Enter tank height (in Level Units selected)	
Antenna Model	<ul style="list-style-type: none"> • RC0 — ¾" horn • RC1 — 1½" horn • RC2 — 2" horn • RC3 — 3" horn • RC2 — 2" Hygienic • RC3 — 3" Hygienic 	
Antenna Mount	Select the type of Antenna Mounting to the vessel (refer to antenna nameplate): <ul style="list-style-type: none"> • NPT (National Pipe Thread) • BSP (British Standard Pipe) • 2" Flange (ASME or EN) • 3" Flange (ASME or EN) • 4" Flange (ASME or EN) • Hygienic 	
Dielectric Range	Enter the Dielectric Range for the material to be measured. Below 1.7 (light hydrocarbons like propane and butane) 1.7 to 3.0 (most typical hydrocarbons) 3.0 to 10 (varying dielectric, for example: mixing tanks) Above 10 (water-based media)	
HART only	4mA Set Point (LRV)	Enter the level value (0%-point) for the 4 mA point. Lower Range Value (LRV). Refer to Section 1.4.1.1.
	20mA Set Point (URV)	Enter the level value (100%-point) for the 20 mA point. Upper Range Value (URV). Refer to Section 1.4.1.1.
	PV Alarm Selection	Enter the desired output state when a Failure Indicator is active. <ul style="list-style-type: none"> • High (22 mA) • Low (3.6 mA) • Hold (hold last value is not recommended for standard configuration). Consult factory.

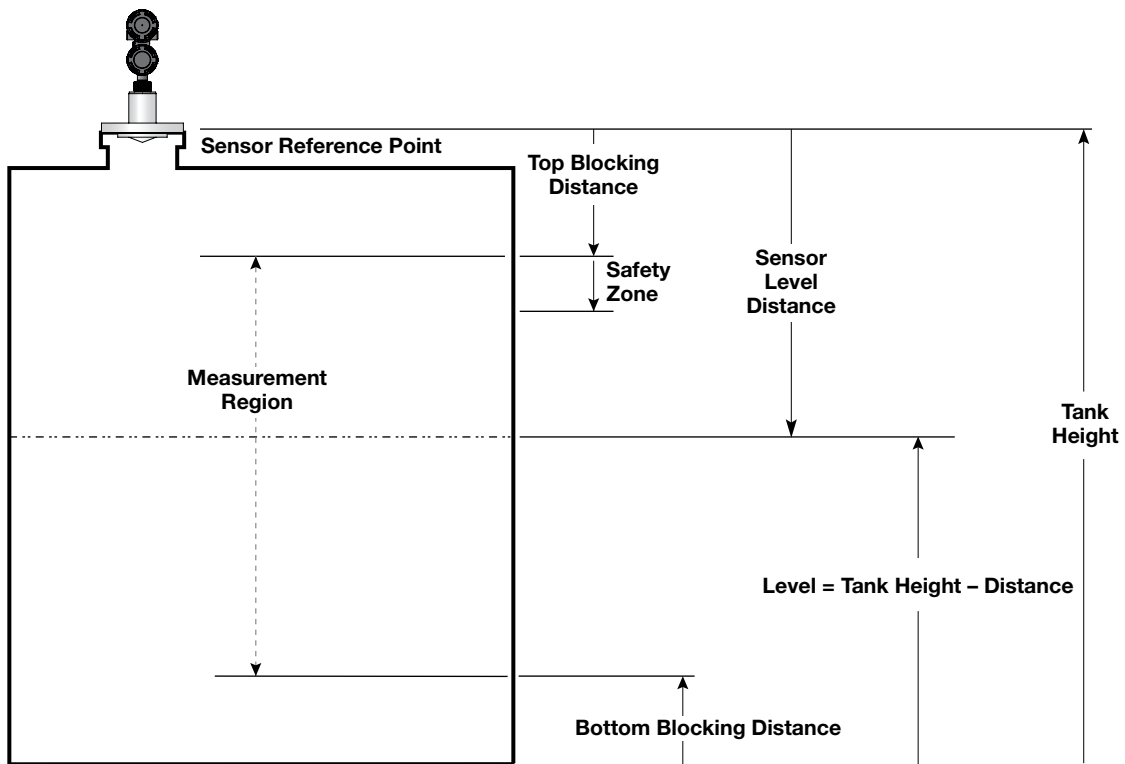

1.4.1.1 Setup Wizard Numerical Data Entry

To make numerical entry changes to Tank Height:

- ⬆ **UP** moves up to the next highest digit (0,1,2,3,.....,9 or the decimal point). If held down, the digits scroll until the push button is released.
- ⬇ **DOWN** moves up to the next lowest digit (0,1,2,3,.....,9 or the decimal point). If held down, the digits scroll until the push button is released.
- ⬅ **BACK** moves the cursor to the left and deletes a digit. If the cursor is already at the leftmost position, then the screen is exited without changing the previously saved value.
- ➡ **ENTER** Moves the cursor to the right. If the cursor is located at a blank character position, the new value is saved.

Scrolling further in the SETUP WIZARD menu results in the remaining parameters appearing one by one, with the present highlighted value shown at the bottom of the screen.

- ⬅ **BACK** returns to the previous menu without changing the original value, which is immediately redisplayed.
- ➡ **ENTER** accepts the displayed value and returns to the previous menu.

2.0 Complete Installation

This section provides detailed procedures for properly installing, wiring, configuring, and, as needed, troubleshooting the Pulsar Model R80 Radar Level Transmitter.

2.1 Unpacking

Unpack the instrument carefully. Make sure all components have been removed from the packing material. Check all contents against the packing slip and report any discrepancies to the factory.

Before proceeding with the installation, do the following:

- Inspect all components for damage. Report any damage to the carrier within 24 hours.
- Make sure the nameplate model number on the antenna and transmitter agree with the packing slip and purchase order.
- Remove plastic protective covers from both the antenna and transmitter. (Store for future use.)
- To avoid moisture ingress in the housing, covers should be fully tightened at all times. For the same reason, plugs should remain properly installed in the cable entries until replaced with a cable gland
- Record the model and serial numbers for future reference when ordering parts.

2.2 Electrostatic Discharge (ESD) Handling Procedure

AMETEK LMS electronic instruments are manufactured to the highest quality standards. These instruments use electronic components that may be damaged by static electricity present in most work environments.

The following steps are recommended to reduce the risk of component failure due to electrostatic discharge.

- Ship and store circuit boards in anti-static bags. If an anti-static bag is not available, wrap the board in aluminum foil. Do not place boards on foam packing materials.
- Use a grounding wrist strap when installing and removing circuit boards. A grounded workstation is recommended.
- Handle circuit boards only by the edges. Do not touch components or connector pins.
- Make sure that all electrical connections are completely made and none are partial or floating. Ground all equipment to a good, earth ground.

WARNING! Potential electrostatic charging hazard. Do not rub with dry cloth.

Model Number

Serial Number

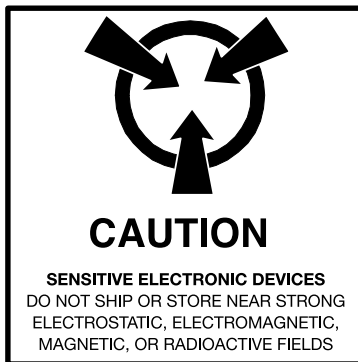

2.3 Before You Begin

2.3.1 Site Preparation

Each Pulsar Model R80 Radar transmitter/antenna is built to match the physical specifications of the required installation. Ensure that the antenna process connection is correct for the threaded or flanged mounting on the vessel where the transmitter will be placed. See Section 2.4, *Mounting*.

Ensure that all local, state, and federal regulations and guidelines are observed. See Section 2.5, *Wiring*.

Ensure that the wiring between the power supply and Pulsar Model R80 Radar transmitter is complete and correct for the type of installation. See Section 3.6, *Specifications*.

2.3.2 Equipment and Tools

No special tools are required. The following items are recommended:

- Threaded antenna and process connectionadjustable wrench
- Transmitter/antenna connection.adjustable wrench
- Torque wrenchhighly desirable
- Flat-blade screwdriver
- Digital multimeter or volt/ammeter optional

2.3.3 Operational Considerations

Radar applications (regardless of operating frequency) are characterized by three basic conditions;

- Dielectric (process medium)
- Distance (measuring range)
- Disturbances (factors such as turbulence,, foam, false targets, multiple reflections and rate of change)

The Pulsar Model R80 Radar transmitter is offered with several horn antenna configurations ($\frac{3}{4}$ " 1 $\frac{1}{2}$ ", 2", 3"). Ideally, if the installation allows, the 3" horn antenna should be used to ensure the best possible performance in all operational conditions.

2.3.3.1 Maximum Distance

The chart below shows the maximum measuring range (Distance) of each antenna based on fundamental conditions of Dielectric, Distance and Turbulence. Distance is measured from the Sensor Reference Point (bottom of NPT thread, top of BSP thread or face of a flange).

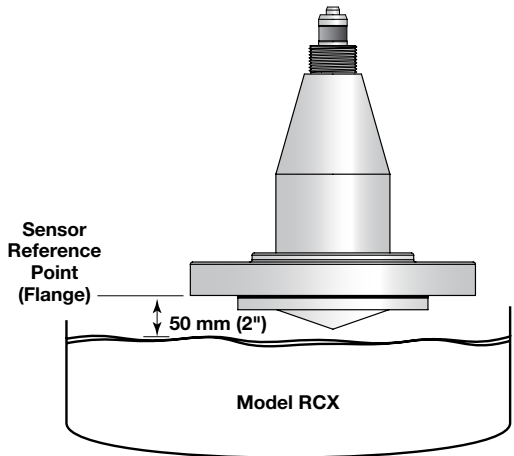

R80 Maximum Recommended Measuring Range in meters (feet)							
Antenna Type	Dielectric >	Turbulence None or Light			Turbulence Medium or Heavy		
		1.4 – 3	3 – 10	10 – 100	1.4 – 3	3 – 10	10 – 100
3/4" Horn		4 (13)	15 (49)	25 (82)	2 (7)	7 (23)	12 (39)
1 1/2" Horn		7 (23)	18 (59)	28 (92)	3 (10)	8 (26)	13 (43)
2" Horn		8 (26)	19 (62)	29 (95)	4 (13)	9 (30)	14 (46)
3" Horn		9 (29)	20 (65)	30 (98)	5 (17)	10 (33)	15 (49)

2.3.3.2 Minimum Distance

Liquid should not be allowed closer than: 50 mm (2 inches) from the bottom of antenna. Refer to illustration at left.

2.3.3.3 Problematic Applications; GWR Alternative

Some applications can be problematic for Non-Contact Radar. For these, Guided Wave Radar is recommended:

- Extremely low dielectric media ($\epsilon_r < 1.7$)
- Stillwells, standpipes, bridles, cages and bypass columns.
- Very weak reflections from the liquid surface (particularly during turbulence) can cause poor performance.
- Tanks heavily cluttered with false targets (mixers, pumps, ladders, pipes, etc.)
- Foam can either absorb or reflect the microwave energy depending upon the depth, dielectric, density and wall thickness of the bubbles. Due to typical variations in the amount (depth) of foam, it is impossible to quantify performance. It may be possible to receive most, some or none of the transmitted energy.
- When measurement close to flange is critical.
 - Extremely high liquid levels (Overflow) conditions when liquid very near the antenna can cause erroneous readings and measurement failure.
- Interface applications

Refer to Eclipse® Model 706 bulletin 57-106 for additional information.

2.4 Mounting

The Pulsar Model R80 Radar transmitter can be mounted to a vessel using a variety of process connections. Generally, either a threaded or flanged connection is used. For information about the sizes and types of connections available, see Section 3.8.2, *Antenna Model Numbers*.

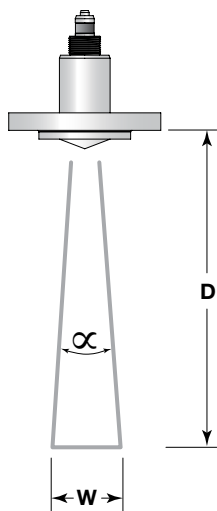
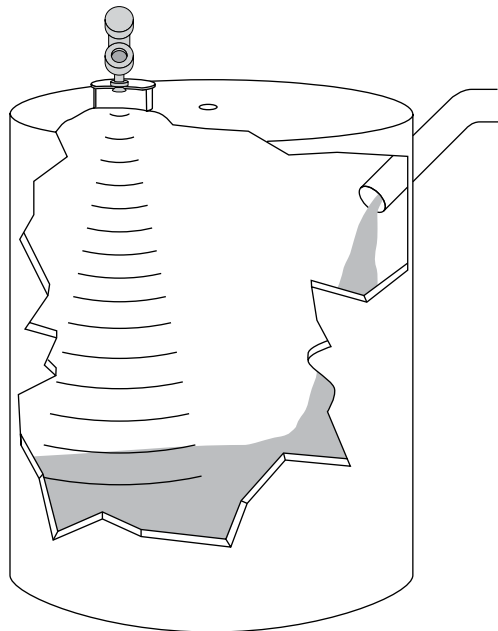

2.4.1 Installing the Antenna

Before installing, ensure that:

- Model and Serial numbers on the nameplates of the Pulsar Model R80 transmitter and antenna are identical.
- Process temperature, pressure, dielectric, turbulence and distance are within the antenna specifications for the installation.
- Protective cap is kept on the antenna if the transmitter is to be installed at a later time.
- Antenna is being mounted in the optimal location. See following sections: *Location*, *Beam Angle*, *Obstructions* and *Nozzles* for specific information.
- If the liquid level comes in contact with the antenna, noise and media buildup drastically decrease reliable measurement. Liquid should not be allowed closer than 50 mm (two inches) from the bottom of the antenna.

2.4.1.1 Location

Ideally, the Radar transmitter should be mounted providing an unobstructed signal path to the liquid surface where it should illuminate (with microwave energy) the largest, possible surface area. See Section 2.4.1.2, *Beam Angle*. Unavoidable obstacles will produce reflections that must be minimized during field configuration. See Section 3.3.3, *Echo Rejection*. Mount in a location equal to 1/2 the radius of tank top. Do not mount in center of vessel nor closer than 30 cm (12 inches) of tank wall. Contact Technical Support when mounting closer than 30 cm (12 inches) is required.

2.4.1.2 Beam Angle

The various horn antennas exhibit slightly different beam patterns. Ideally, the beam pattern should illuminate the maximum liquid surface with minimum contact with other objects in the vessel including the tank wall. Use the chart at left to determine the optimum installation location.

meters (feet)

Antenna Beam Angle (α)	Beam Spread, W @-3dB; ft (m)			
	¾" Horn 13°	1½" Horn 7°	2" Horn 6°	3" Horn 4°
Distance, D				
3 (10)	0.7 (2.3)	0.4 (1.2)	0.3 (1.1)	0.2 (0.7)
6 (20)	1.4 (4.6)	0.8 (2.5)	0.6 (2.1)	0.4 (1.4)
9 (30)	2.1 (6.9)	1.1 (3.7)	1.0 (3.2)	0.6 (2.1)
12 (40)	2.8 (9.2)	1.5 (4.9)	1.3 (4.2)	0.8 (2.8)
15 (50)	3.5 (11.5)	1.9 (6.1)	1.6 (5.3)	1.0 (3.5)
23 (75)	5.3 (17.3)	2.8 (9.2)	2.4 (7.9)	1.6 (5.2)
30 (100)	7.0 (23.1)	3.7 (12.3)	3.2 (10.5)	2.1 (7.0)

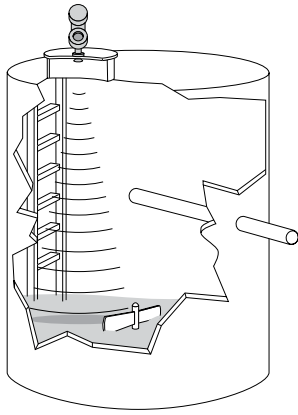

2.4.1.3 Obstructions

Almost any object that falls within the beam pattern will cause reflections that may be misinterpreted as a false liquid level. Although Pulsar Model R80 has a powerful Echo Rejection routine, all possible precautions should be taken to minimize false target reflections with proper installation and orientation. Refer to Section 4.0, *Advanced Configuration/ Troubleshooting Techniques* for additional information.

2.4.1.4 Nozzles

Improper installation in a nozzle can create “ringing” that can adversely affect measurement. See Section 3.6.8 for dimensional drawings of all antenna designs.

Be sure to include any nozzle distance extending down within the vessel.

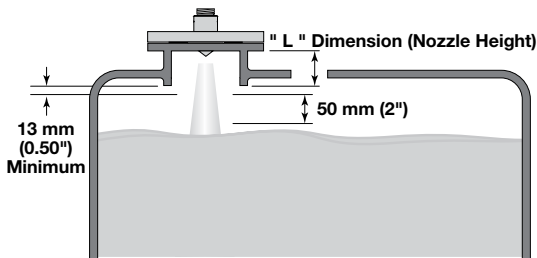

2.4.1.5 Standpipes and Stillwells

The Pulsar Model R80 may be mounted in a standpipe or stillwell but certain items must be considered:

- Metal stillwells only
- Diameter must be consistent throughout length; no reducers or gaps.
- Stillwell length must cover complete range of measurement (i.e., liquid must be in stillwell).
- Internal welds should be smooth.
- Vents: holes <3 mm (0.125") diameter, slots <3 mm (0.125") width.
- If an isolation valve is used, it must be a full port ball valve with an I.D. equal to the pipe diameter.
- Configuration must include a proper PIPE I.D parameter.

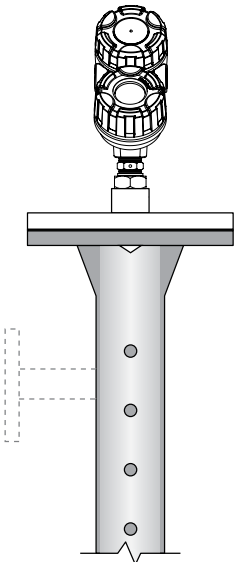

Pulsar Model R80 Mounted in Stillwell (Bridle)

2.4.2 Installing the Transmitter

- Remove the protective plastic cap from the top of antenna. Store the cap in a safe place in case the transmitter has to be removed later.
- Carefully place the transmitter on the antenna.
- Rotate the transmitter to face the most convenient direction for wiring, configuration and viewing.

NOTE: ALWAYS RUN THE ECHO REJECTION ROUTINE AFTER MAKING CHANGES TO MENU ITEMS (**Antenna Model, Antenna Mount, Tank Height, Dielectric, Turbulence, Rate of Change, Foam**).

2.4.2.1 Echo Margin

Echo Margin is a parameter that, when used with Echo Strength, can be a very useful troubleshooting tool. In very basic terms, it is defined as a numeric value that is related to the strength of the target peak relative to the Level Threshold.

Echo Loss: If the Level signal is lost repeatedly at a specific point in the vessel, it is usually a symptom of multipath (side-wall) reflections causing cancellation by returning to the transmitter exactly 180° out of phase with the actual Level signal. This can be improved by applying the following procedure:

- Scroll to Display Config Menu under Device Setup. Scroll down to Echo Strength and Echo Margin and change the settings from Hide to View. This will allow you to view these values from the home screen.
- Bring the Level up (or down) to the exact point where the signal is repeatedly lost. Monitor the Echo Margin value as this point is being approached. The Echo Margin value will degrade to a low point before it begins to increase.
- Refer to Section 4.4 for additional information.

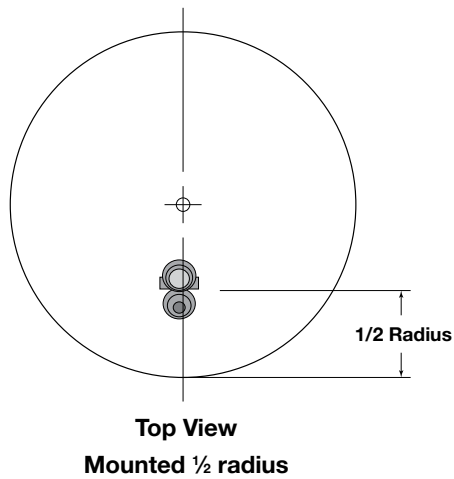

2.5 Wiring

Caution: HART versions of the Pulsar Model R80 transmitter operate at voltages of 11–36 VDC (SELV). Higher voltages will damage the transmitter.

Wiring connections between the power supply and the Pulsar Model R80 Radar transmitter should be made using 0.5–1 mm² (18–22 AWG) shielded twisted pair instrument cable. Connections are made to the terminal strip and the ground connections within the top enclosure compartment. Wiring connections are to be torqued to a minimum of 7 in. lbs. and shall not exceed 10 in. lbs.

The instructions for wiring the Pulsar Model R80 transmitter depend on the application:

- General Purpose or Division 2
- Intrinsically Safe
- Explosion Proof

WARNING! Explosion hazard. Do not disconnect equipment unless power has been switched off or the area is known to be non-hazardous.

To avoid moisture ingress in the housing, covers should be fully tightened at all times. For the same reason, cable gland and plugs should be properly installed in the cable entries.

2.5.1 General Purpose or Division 2

A general purpose installation does not have flammable media present. Areas rated Division 2 have flammable media present only under abnormal conditions. 24 VDC (SELV) electrical connections are required.

Caution: If flammable media is contained in the vessel, the transmitter must be installed per Class I, Div 1 standards of area classification.

To install General Purpose or Division 2 wiring:

1. Remove the cover from the wiring compartment of the transmitter. Install the conduit plug in the unused opening and use PTFE tape/sealant to ensure a liquid-tight connection.
2. Install a conduit fitting and pull the supply wires.
3. Connect shield to an earth ground at power supply.
4. Connect an earth ground wire to the nearest green ground screw (not shown in illustration).
5. Connect the positive supply wire to the (+) terminal and the negative supply wire to the (-) terminal.
6. Replace and tighten the cover to the transmitter wiring compartment before applying power.

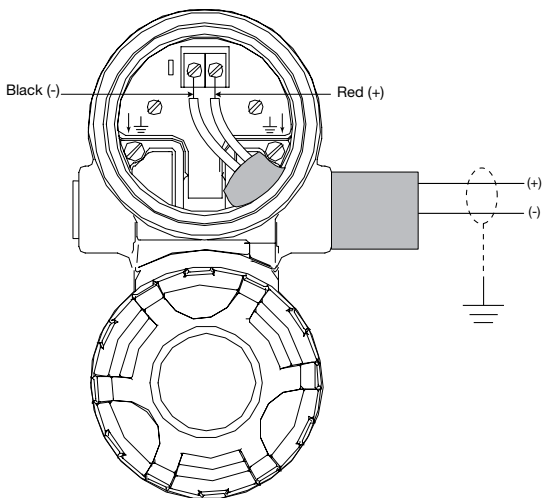

2.5.2 Intrinsically Safe

An Intrinsically Safe (IS) installation potentially has flammable media present. An approved IS barrier must be installed in the non-hazardous (safe) area to limit the available energy out to the hazardous area.

See *Agency Drawing – Intrinsically Safe Installation*, Section 3.5.1.

To install Intrinsically Safe wiring:

1. Ensure that the IS barrier is properly installed in the safe area (refer to local plant or facility procedures). Complete the wiring from the power supply to the barrier and from the barrier to the Pulsar Model R80 transmitter.
2. Remove the cover from the wiring compartment of the transmitter. Install the conduit plug in the unused opening and use PTFE tape/sealant to ensure a liquid-tight connection.
3. Install a conduit fitting and pull the supply wires.
4. Connect shield to an earth ground at power supply.
5. Connect an earth ground wire to the nearest green ground screw (not shown in illustration).
6. Connect the positive supply wire to the (+) terminal and the negative supply wire to the (-) terminal.
7. Replace and tighten the wiring compartment cover of the transmitter before applying power.

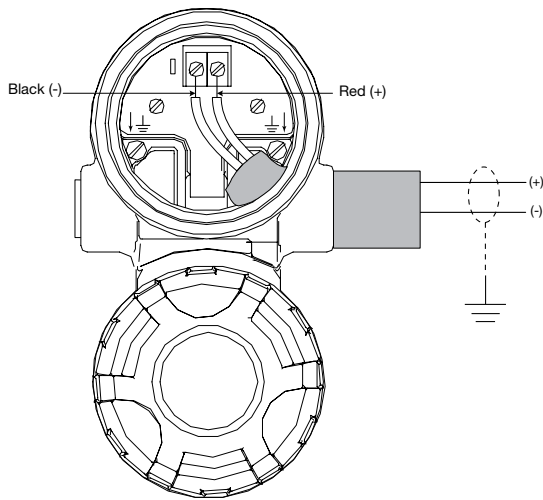

2.5.3 Explosion Proof

Explosion Proof (also referred to as XP or flameproof) is another method of designing equipment for installation into hazardous areas. A hazardous location is an area in which flammable gases or vapors are (or may be) present in the air in quantities sufficient to produce explosive or ignitable mixtures.

The wiring for the transmitter must be contained in Explosion Proof conduit extending into the safe area.

- An Explosion Proof conduit fitting (EY seal) is required between the hazardous and safe areas. See Section 3.5, *Agency Specifications*.

To install an Explosion Proof transmitter:

1. Install Explosion Proof conduit from the safe area to the conduit connection of the Pulsar Model R80 transmitter (refer to local plant or facility procedures).
2. Remove the cover from the wiring compartment of the transmitter.
3. Connect shield to an earth ground at the power supply.
4. Connect an Earth ground wire to the nearest green ground screw per local electrical code (not shown in illustration).
5. Connect the positive supply wire to the (+) terminal and the negative supply wire to the (-) terminal.
6. Replace and tighten the cover to the wiring compartment of the transmitter before applying power.

2.6 Configuring the Transmitter

Although the Pulsar Model R80 transmitter can be delivered pre-configured from the factory, it can also be easily reconfigured in the shop or at the installation using the local LCD/Keypad or PACTware/DTM. Bench configuration provides a convenient and efficient way to set up the transmitter before going to the tank site to complete the installation.

Before configuring any transmitter, collect all operating parameters information (refer to Section 1.1.2).

Apply power to the transmitter and follow the step-by-step procedures for the menu-driven transmitter display. Refer to Sections 2.6.2 and 2.6.4.

Information on configuring the transmitter using a HART communicator is given in Section 2.7, *Configuration Using HART*.

2.6.1 Bench Configuration

The Pulsar Model R80 transmitter can be easily configured at a test bench by connecting a standard 24 VDC (SELV) power supply directly to the transmitter terminals as shown in the accompanying diagram.

NOTE: When using a HART communicator for configuration, a minimum 250-ohm line load resistance is required. Refer to your HART communicator manual for additional information.

NOTE: The transmitter can be configured without the antenna attached. Disregard any diagnostic indicators that may appear during that time.

2.6.2 Menu Traversal and Data Entry

The four push buttons offer various forms of functionality for navigation and data entry.

The Pulsar Model R80 user interface is hierarchical in nature, best described as a tree structure. Each level in the tree contains one or more items. Items are either menu labels or parameter names.

- Menu labels are presented in all capital letters
- Parameters are capital words

2.6.2.1 Navigating the Menu

⬆ **UP** moves to the previous item in the menu branch.

⬇ **DOWN** moves to the next item in the menu branch.

⬅ **BACK** moves back one level to the previous (higher) branch item.

➡ **ENTER** enters into the lower level branch or switches to the entry mode. Holding the ENTER down on any highlighted menu name or parameter will show help text for that item.

2.6.2.2 Data Selection

This method is used for selecting configuration data from a specific list.

⬆ **UP** and ⬇ **DOWN** to navigate the menu and highlight the item of interest

➡ **ENTER** allows modification of that selection

⬆ **UP** and ⬇ **DOWN** to choose new data selection

➡ **ENTER** to confirm selection





Use ⬅ **BACK** (Escape) key at any time to abort the procedure and escape to previous branch item.



Up Down Back Enter

2.6.2.3 Entering Numeric Data Using Digit Entry

This method is used to input numeric data, e.g., Tank Height, 4 mA setpoint and 20 mA setpoint.





Push Button		Keystroke Action
	Up	Moves up to the next highest digit (0,1,2,3,....,9 or decimal point). If held down the digits scroll until the push button is released.
	Down	Moves down to the next lowest digit (9,8,7... or decimal point). If held down the digits scroll until the push button is released.
	Back	Moves the cursor to the left and deletes a digit. If the cursor is already at the leftmost position, then the screen is exited without changing the previously saved value.
	Enter	Moves the cursor to the right. If the cursor is located at a blank character position, the new value is saved.

All numeric values are left-justified, and new values are entered from left to right. A decimal point can be entered after the first digit is entered, such that .9 is entered as 0.9.

Some configuration parameters can have a negative value. In this case, the leftmost position is reversed for the sign (either "-" for a negative value, or "+" for a positive value).

2.6.2.4 Entering Numeric Data Using Increment/Decrement





Use this method to input the following data into parameters such as Damping and Failure Alarm.

Push Button		Keystroke Action
	Up	Increments the displayed value. If held down the digits scroll until the push button is released. Depending on which screen is being revised, the increment amount may increase by a factor of 10 after the value has been incremented 10 times.
	Down	Decrements the displayed value. If held down the digits scroll until the push button is released. Depending on which screen is being revised, the decrement amount may increase by a factor of 10 after the value has been decremented 10 times.
	Back	Returns to the previous menu without changing the original value, which is immediately redisplayed.
	Enter	Accepts the displayed value and returns to the previous menu.

2.6.2.5 Entering Character Data

This method is used for parameters requiring alphanumeric character entry, such as for entering tags, etc.

General Menu Notes:

Push Button		Keystroke Action
	Up	Moves to the previous character (Z...Y...X...W). If held down, the characters scroll until the push button is released.
	Down	Moves to the next item character (A...B...C...D). If held down, the characters scroll until the push button is released.
	Back	Moves the cursor back to the left. If the cursor is already at the leftmost position, then the screen is exited without changing the original tag characters.
	Enter	Moves the cursor forward to the right. If the cursor is at the rightmost position, then the new tag is saved.

2.6.3 Password Protection

The Pulsar Model R80 transmitter has three levels of password protection to restrict access to certain portions of the menu structure that affect the operation of the system.

User Password

The User Password allows the customer to limit access to the basic configuration parameters.

The default User Password installed in the transmitter at the factory is 0. With a password of 0, the transmitter is no longer password protected and any value in the basic user menus can be adjusted without entering a confirming password.

The user password can be changed to any numerical value up to 59999. When the transmitter is programmed for password protection, a password is required whenever configuration values are changed.

NOTE: If a User Password is not known or has been misplaced, the menu item New Password in the DEVICE SETUP/ADVANCED CONFIG menu displays an encrypted value representing the present password. Contact Technical Support with this encrypted password to retrieve the original User Password.

Advanced Password

Certain portions of the menu structure that contain more advanced parameters are further protected by an Advanced Password.

This password will be provided, when necessary, by Factory technical support.

Factory Password

Calibration-related and other factory settings are further protected by a Factory Password.

2.6.4 Model R80 Menu: Step-By-Step Procedure

NOTE: Context-sensitive HELP is available for all menu and parameter items. With the item highlighted, hold down the **ENTER** key for two seconds. Use **UP** and **DOWN** for navigation.

The tables in Section 2.6.5 provide a complete explanation of the software menus displayed by the Pulsar Model R80 transmitter. The menu layout is similar between the local Keypad/LCD interface, the DD, and the DTM.

Use these tables as a step-by-step guide to configure the transmitter based on the desired measurement type from the following selections:

- **Level Only**
- **Volume & Level**
- **Flow**

HOME SCREEN

The Home Screen consists of a “slide show” sequence of Measured Values screens which are rotated at 2-second intervals. Each Home Measured Value screen can present up to four information items:

- **HART® Tag**
- **Measured Value**
Label, Numerical Value, Units
- **Status**
Will be displayed as text or optionally with NAMUR NE 107 symbol
- **Primary Value Bar Graph** (shown in %)

The Home Screen presentation can be customized by viewing or hiding some of these items. See DISPLAY CONFIG under the DEVICE SETUP menu in Section 2.6.5, *Configuration Menu*.

At left is an example of a Home Screen for a Model R80 configured for a standard level application.



Up Down Back Enter



MAIN MENU

Pressing any key on the Home Screen will present the Main Menu, consisting of four basic menu labels shown in all capital letters.

- **DEVICE SETUP**
- **DIAGNOSTICS**
- **MEASURED VALUES**
- **WIZARDS**

As shown, the reverse video represents a cursor identifying the selected item, which will appear in reverse video on the LCD. The actions of the keys at this point are:

Push Button		Keystroke Action
	Up	Moves cursor to MEASURED VALUES
	Down	No action as the cursor is already at the last item in the list.
	Back	Moves back to HOME SCREEN, the level above MAIN MENU
	Enter	Presents the selected item, WIZARDS

- NOTES: 1. Items and parameters that are shown in lower level menus will depend on the Measurement Type chosen. Those parameter not applicable to the present Measurement Type will be hidden.
2. Holding down the Enter key when the cursor is highlighted over a parameter or menu will provide additional information about that item.



DEVICE SETUP

Choosing DEVICE SETUP from the MAIN MENU will result in an LCD presentation as shown at left.

The small down arrow shown at the right hand side of the screen is the indication that more items are available below and can be accessed by pressing the DOWN key.

Section 2.6.5 shows the entire tree menu for the Model R80 Device Setup Menu.

DIAGNOSTICS

Refer to Section 3.4

MEASURED VALUES

Allows the user to scroll through all of the available measured values for the measurement type chosen.

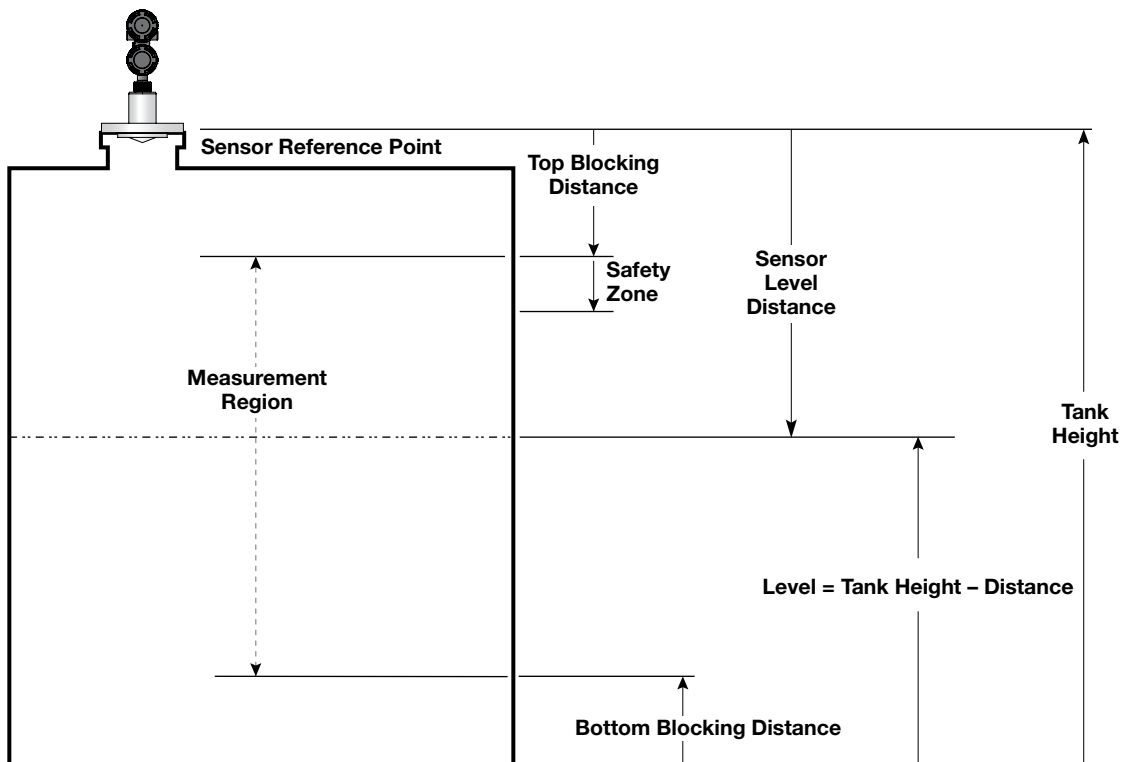

R80 Level Model

2.6.5 Model R80 Configuration Menu – Device Setup

NOTE: Context-sensitive HELP is available for all menu items. With the menu item highlighted, hold down the **ENTER** key for two seconds. Use **UP** and **DOWN** for navigation.

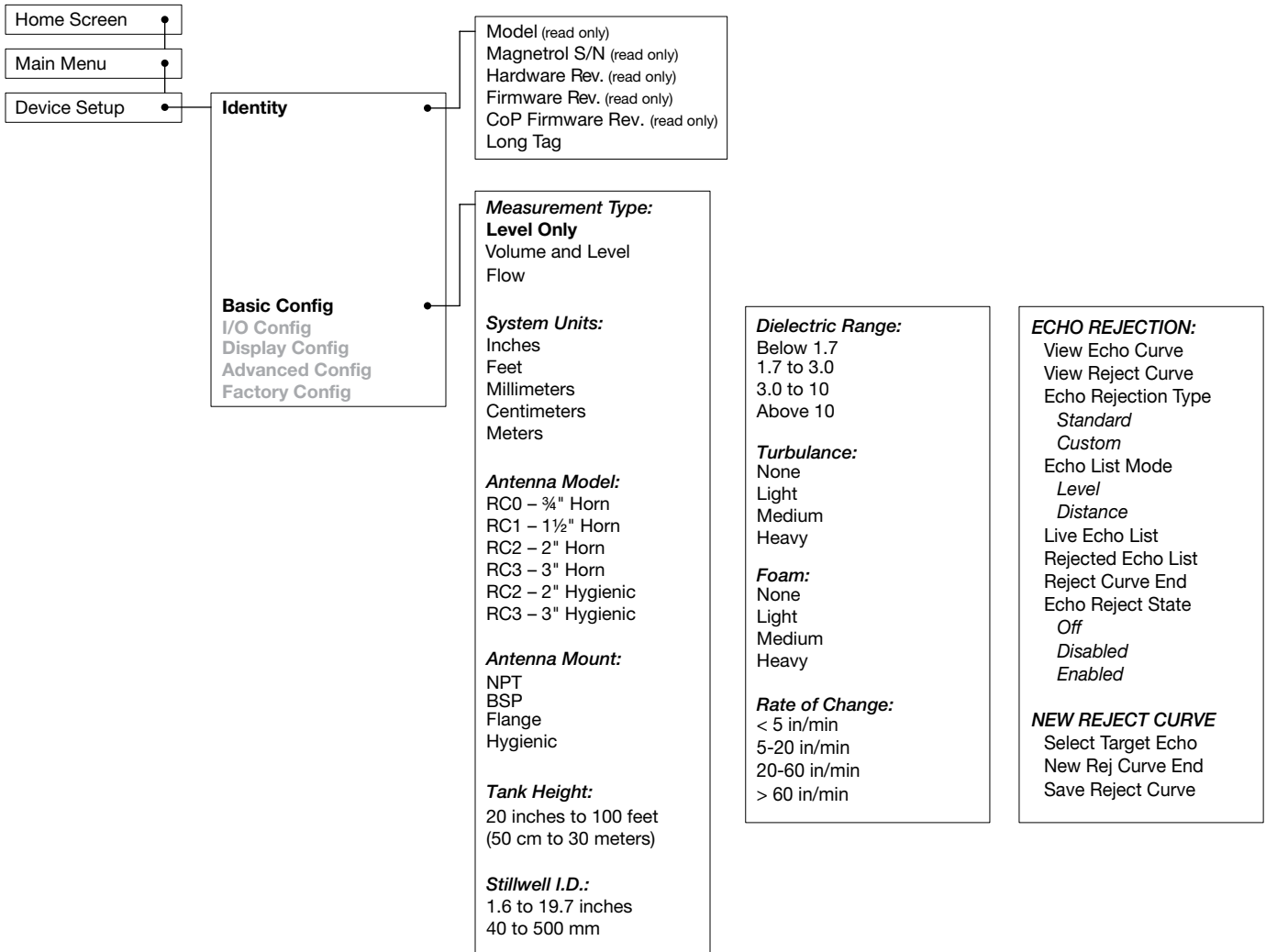

2.6.5 Model R80 Configuration Menu – Device Setup

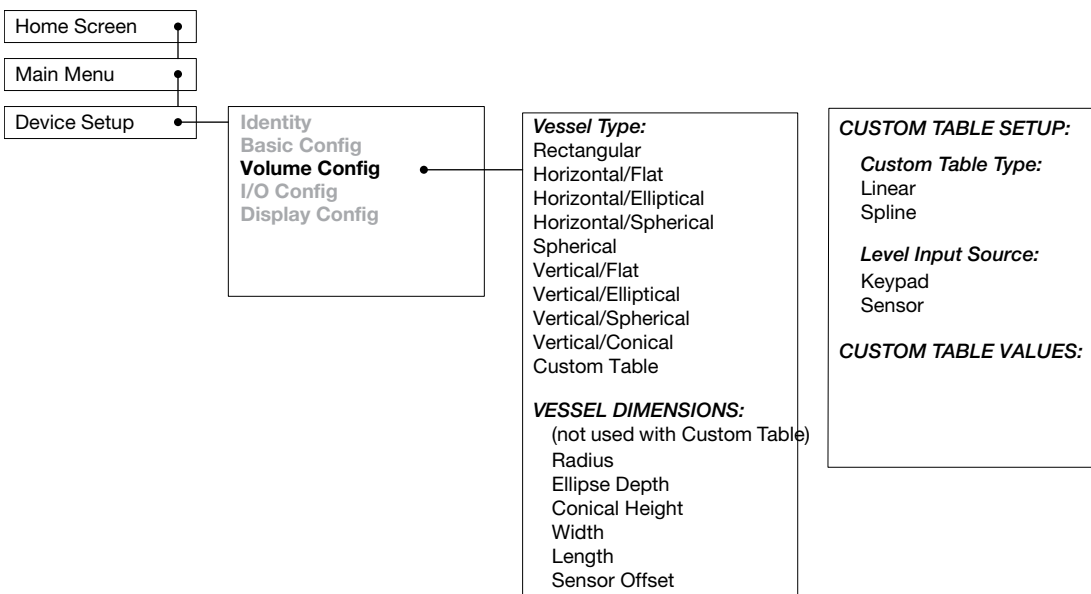
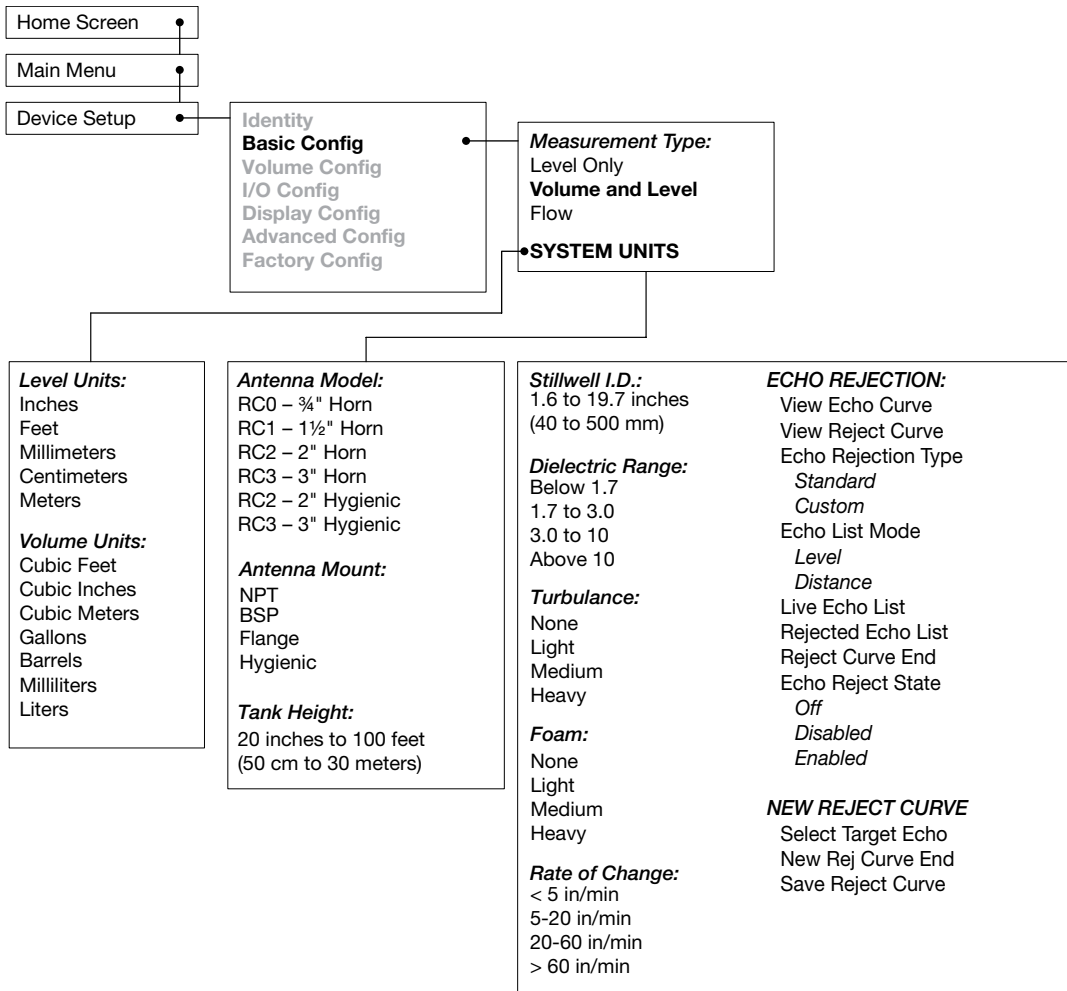

2.6.5 Model R80 Configuration Menu – Device Setup

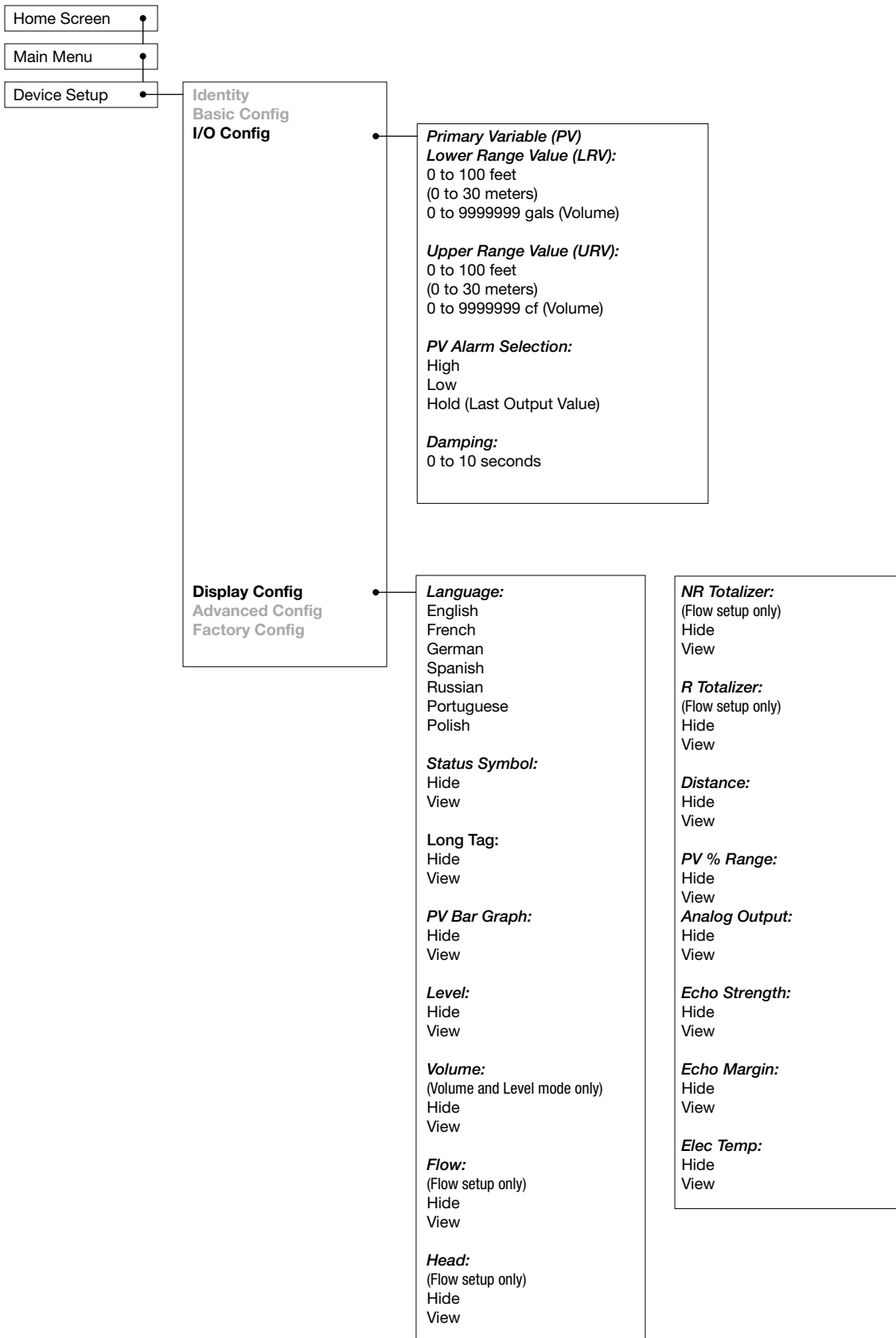

2.6.5 Model R80 Configuration Menu – Device Setup

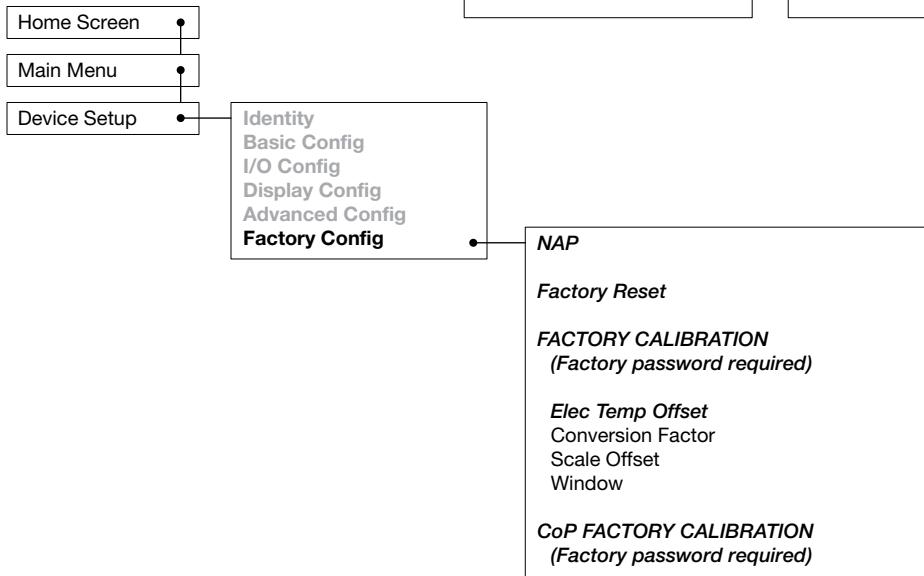
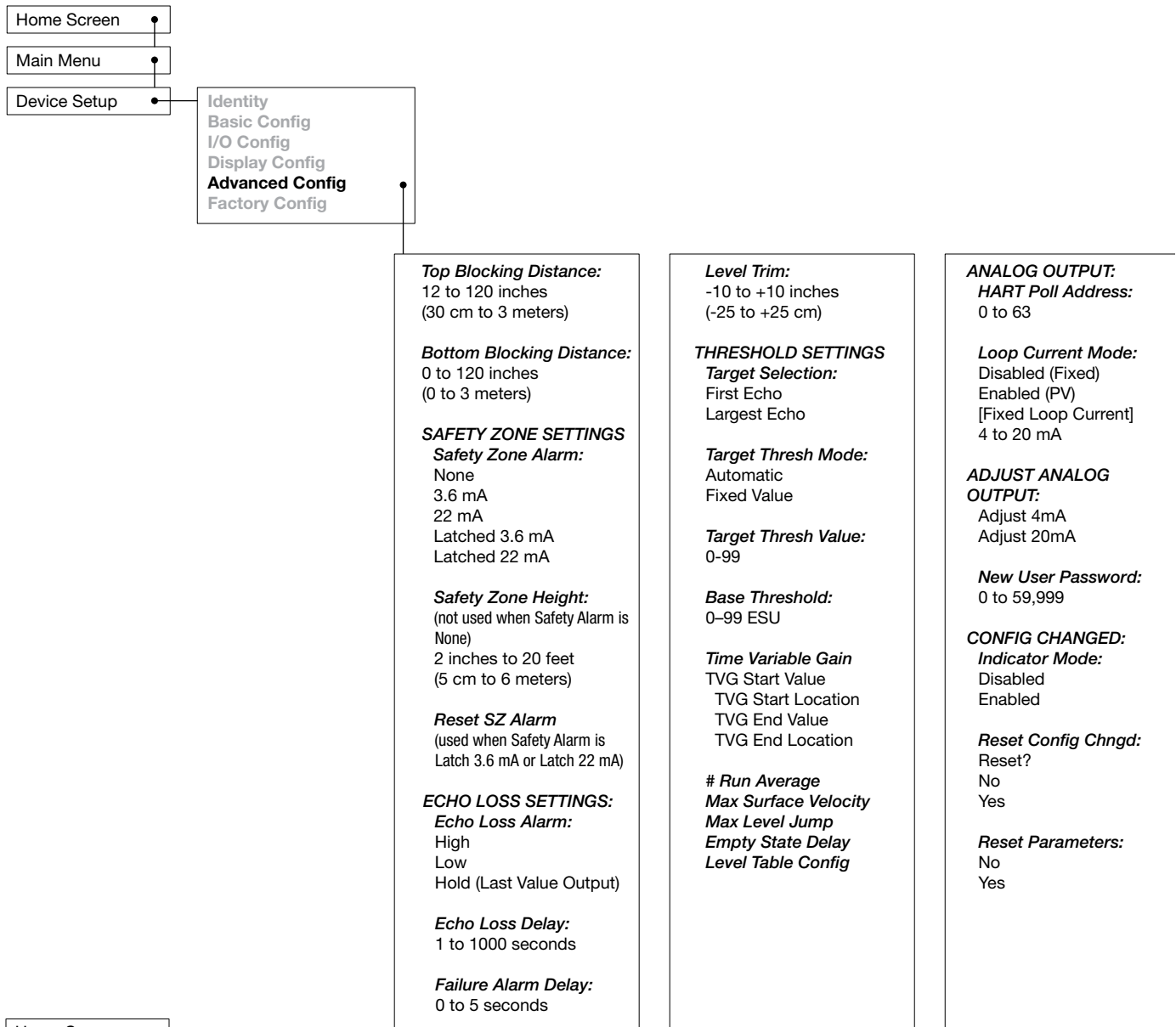

2.7 Configuration Using HART®

A HART (Highway Addressable Remote Transducer) remote unit, such as a HART communicator, can be used to provide a communication link to the Pulsar Model R80 transmitter. When connected to the control loop, the same system measurement readings shown on the transmitter are also shown on the communicator. The communicator can also be used to configure the transmitter.

The HART communicator may need to be updated to include the Pulsar Model R80 software (Device Descriptions). Refer to your HART Communicator Manual for update instructions.

One can also access configuration parameters using PACTware and the Model R80 DTM, or using the AMS with EDDL.

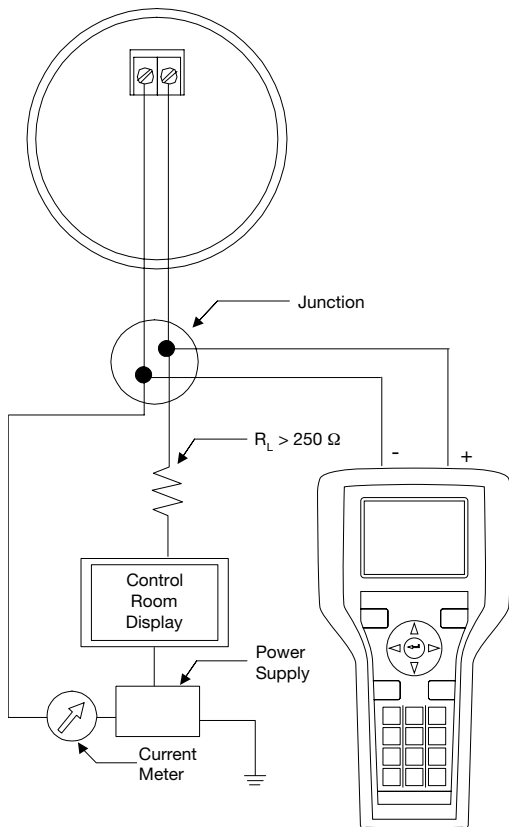

2.7.1 Connections

A HART communicator can be operated from a remote location by connecting it to a remote junction or by connecting it directly to the terminal block in the electronics housing of the Pulsar Model R80 transmitter.

HART uses the Bell 202 frequency shift key technique of high-frequency digital signals. It operates on the 4–20 mA loop and requires 250 Ω load resistance. A typical connection between a communicator and the Pulsar Model R80 transmitter is illustrated.

2.7.2 Display Menu

A typical communicator display is an 8-line by 21-character LCD. When connected, the top line of each menu displays the model (Model R80) and its tag number or address. For detailed operating information, refer to the instruction manual provided with the HART communicator.

The Pulsar Model R80 transmitter online menu trees are shown in the following illustration. Open the menu by pressing the alphanumeric key 4, Device Setup, to display the second-level menu.

2.7.3 Model R80 HART Revision Table

HART Version	HCF Release Date	Compatible with R80 Software
Dev V1 DD1	September 2022	Version 1.0a and later

2.7.4 HART Menu

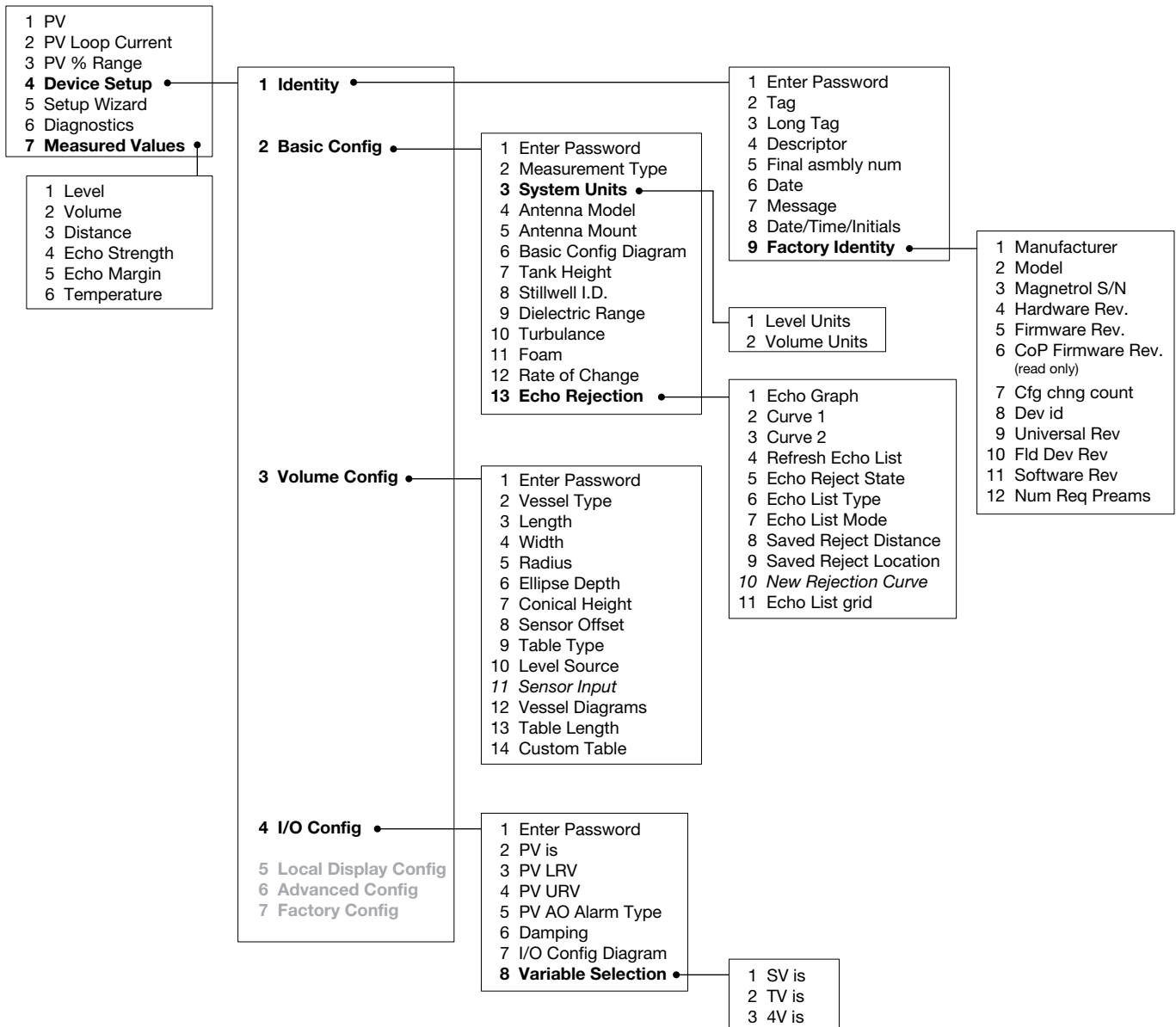

2.7.4 HART Menu (continued)

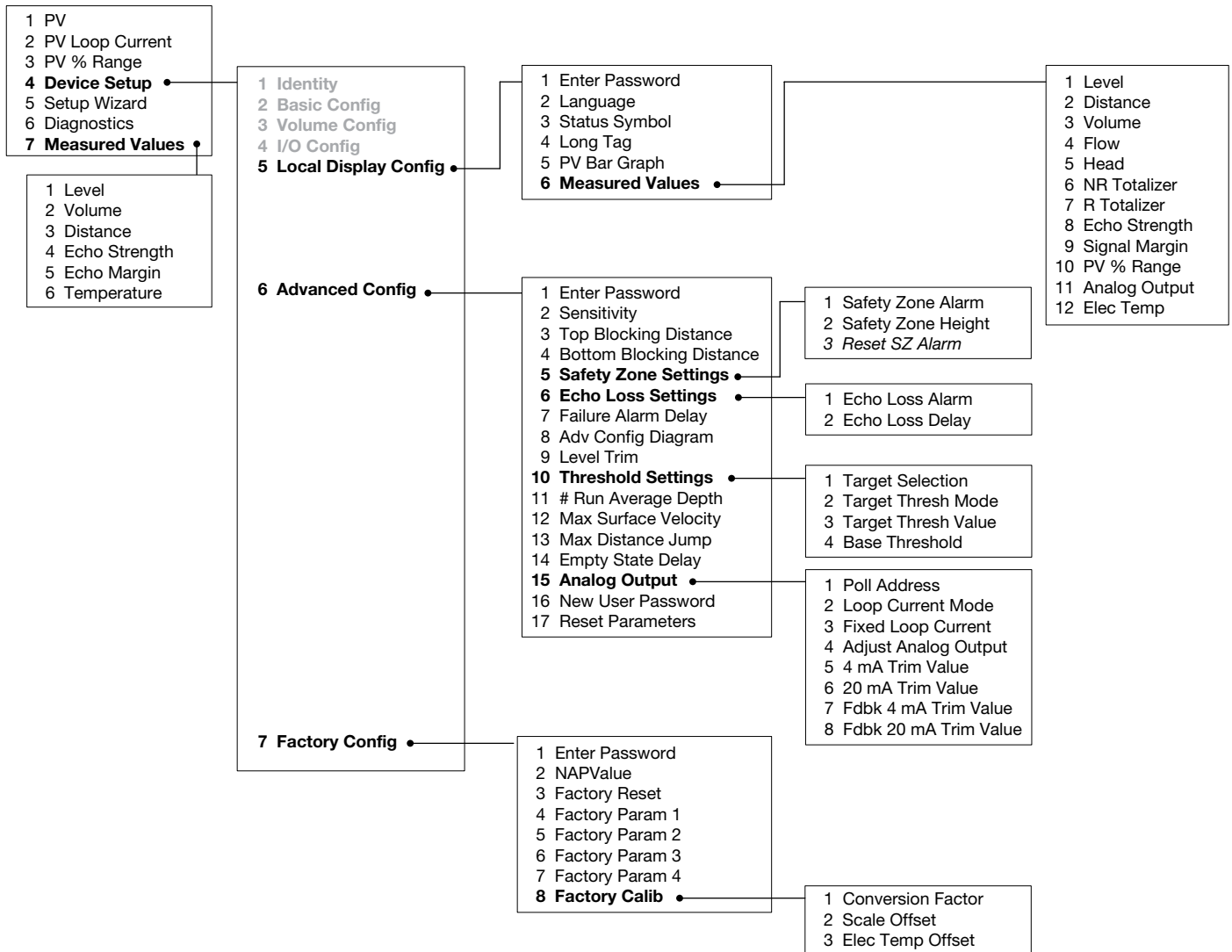

3.0 Reference Information

This section presents an overview of the operation of the Pulsar Model R80 Radar Level Transmitter, information on troubleshooting, common problems, listings of agency approvals, lists of replacement and recommended spare parts, and detailed physical, functional and performance specifications.

3.1 Description

The Pulsar Model R80 is a two-wire, 24 VDC (SELV), level transmitter based on the concept of Frequency Modulated Continuous Wave (FMCW) radar. The electronics are housed in an ergonomic housing comprised of two tandem compartments angled at a 20-degree angle for ease of wiring and calibration. These two compartments connect via a watertight feed-through.

3.2 Theory of Operation

3.2.1 Frequency Modulated Continuous Wave (FMCW) Radar

The Pulsar R80 is a top-mounted FMCW radar transmitter operating at 80 GHz. Unlike previous Pulsar transmitters that emit short bursts of 26 GHz energy and measure the transit time of the signal reflected off the liquid surface, FMCW devices transmit a continuous signal with a constantly changing frequency down toward the liquid.

The detected difference in frequencies between the transmitted signal and return echo is a function of the distance. Level is then calculated by factoring in tank height and other configuration information. The reference point for distance and level calculations is the sensor reference point (bottom of an NPT thread, top of a BSP thread, or face of the flange).

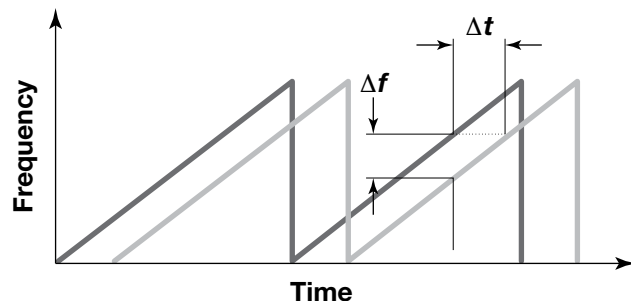
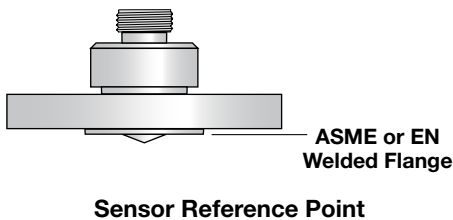

FMCW captures its process variable information in the frequency domain, which supports more accurate signal conversion. The main advantage of FMCW is that it utilizes higher receiving sensitivity and higher-strength signals over pulse systems, allowing it to perform better in difficult situations where there may be turbulence, foam or excessive vapors.

The exact level measurement is extracted from false target reflections and other background noise via the use of sophisticated signal processing. The new Pulsar Model R80 circuitry is extremely energy efficient so no duty cycling is necessary to accomplish effective measurement.

3.3 Configuration Information

This section is intended to offer additional configuration-related details with respect to some of the parameters shown in the Menu in Section 2.6.

3.3.1 Bottom Blocking Distance Description

The parameter referred to as Bottom Blocking Distance in the Pulsar Model R80 Device Setup/ADVANCED Config menu is defined as the distance from the bottom of the tank to the lowest valid level reading.

NOTE: The level reading will never be lower than the Bottom Blocking Distance or higher than the Top Blocking Distance.

The Pulsar Model R80 transmitter is shipped from the factory with Bottom Blocking Distance set to 0. With this configuration, level measurements are referenced from the bottom of the range. See Example 1.

Example 1 (Bottom Blocking Distance = 0 as shipped from factory):

Application calls for a Model RC2 antenna in an 82-inch tank with a flanged process connection. The process medium is water.

The user wants the 4 mA Set Point (LRV) at 0 inches and the 20 mA Set Point (URV) at 60 inches as referenced from the bottom of the tank.

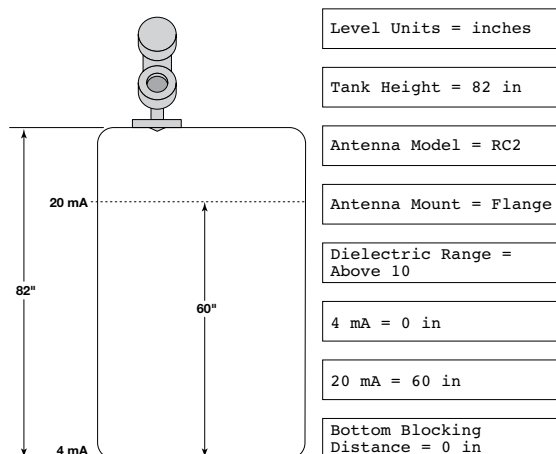

Example 1

Example 2 (Bottom Blocking Distance = 10 inches):

Application calls for a Model RC3 antenna in an 100-inch tank with a flanged process connection.

The user wants the 4 mA Set Point (LRV) at 24 inches and the 20 mA Set Point (URV) at 60 inches as referenced from the bottom of the tank.

When the Pulsar Model R80 transmitter is mounted in a side-mounted chamber, it is usually desirable to configure the unit with the 4 mA Set Point (LRV) at the lower process connection and the 20 mA Set Point (URV) at the upper process connection. The measuring range then becomes the center-to-center dimension.

Example 3:

Application calls for a Model RC3 flanged antenna measuring water in a 3-inch chamber. The user wants the 4 mA point at the bottom process connection and the 20 mA point at the top process connection.

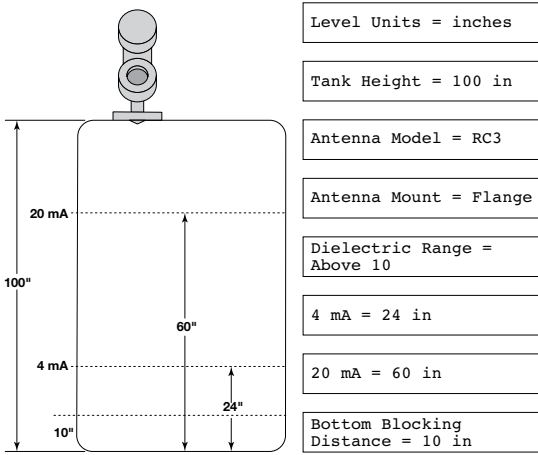

Example 2

3.3.2 Reset Function

A parameter labeled “Reset Parameters” is located at the end of the DEVICE SETUP/ADVANCED CONFIG menu. In the event a user gets confused during configuration or advanced troubleshooting, this parameter gives the user the ability to reset the Model R80 transmitter configuration.

Unique to the Model R80 transmitter is the ability for Magnetrol to fully “pre-configure” devices to customer requests. For that reason, the Reset function will return the device back to the state at which it left the factory.

It is recommended that AMETEK LMS Technical Support be contacted as the Advanced User password will be required for this reset.

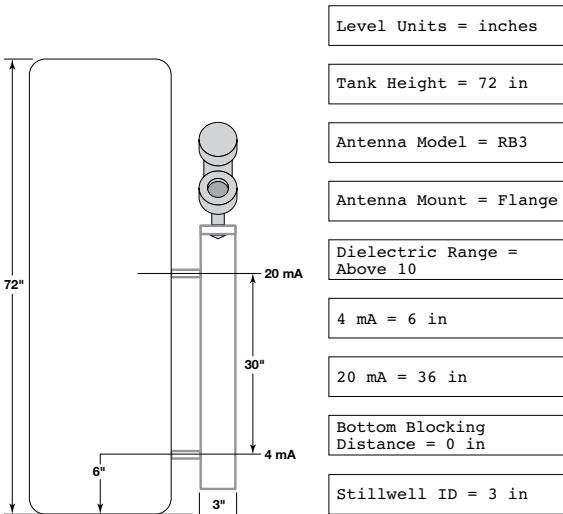

Example 3

3.3.3 Echo Rejection

Since all Non-Contact radar transmitters are application/installation dependent, Echo Rejection (ignoring false targets) may be necessary.

The Model R80 transmitter Echo Rejection feature is located in the Device Setup/BASIC Config menu, and requires the User Password to activate. It is highly recommended that this feature be used with the waveform capture capability of the Model R80 DTM and PACTware™.

Refer to Section 4.0, *Advanced Configuration/ Troubleshooting Techniques* or contact Magnetrol Technical Support for additional instructions.

3.3.4 Volumetric Capability

Selecting Measurement Type = Volume and Level allows the Model R80 transmitter to measure volume as the Primary Measured Value.

3.3.4.1 Configuration using built-in Vessel Types

The following table provides an explanation of each of the System Configuration parameters required for volume applications that use one of the nine Vessel Types.

MEASUREMENT TYPE = LEVEL & VOLUME

Configuration Parameter	Explanation
System Units	A selection of Gallons, Barrels, Milliliters, Liters, Cubic Feet, or Cubic Inches, is provided. (Factory default is Cubic Feet)
Vessel Type	Select either Vertical/Flat (factory default Vessel Type), Vertical/Elliptical, Vertical/Spherical, Vertical/Conical, Rectangular, Horizontal/Flat, Horizontal/Elliptical, Horizontal/Spherical, Spherical, or Custom Table. Note: Vessel Dims is the next screen only if a specific Vessel Type was selected. If Custom Table was selected. Refer to page 43 to select the Cust Table Type and Cust Table Vals.
Vessel Dims	See the vessel drawings on the following page for relevant measuring areas.
Radius	Used for all Vessel Types with the exception of Rectangular.
Ellipse Depth	Used for Horizontal and Vertical/Elliptical vessels.
Conical Height	Used for Vertical/Conical vessels.
Width	Used for Rectangular vessels.
Length	Used for Rectangular and Horizontal vessels.

Vessel Types

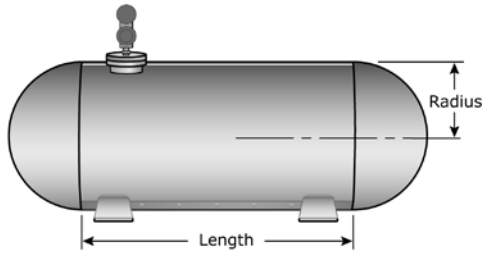

HORIZONTAL/SPHERICAL

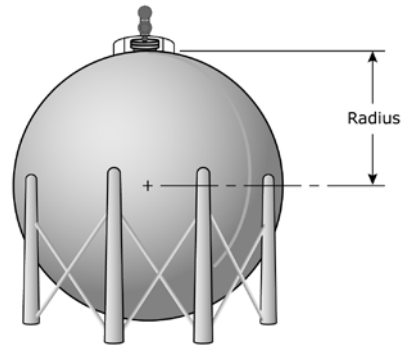

SPHERICAL

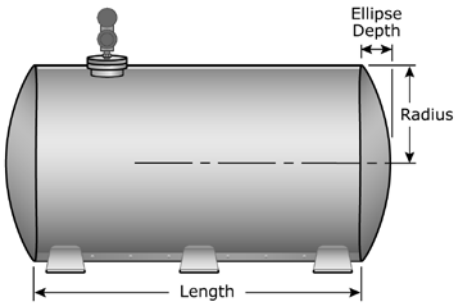

HORIZONTAL/ELLIPTICAL

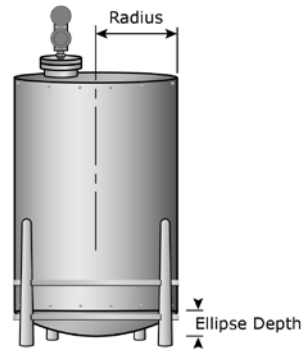

VERTICAL/ELLIPTICAL

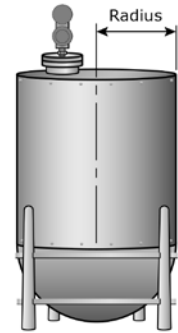

VERTICAL/SPHERICAL

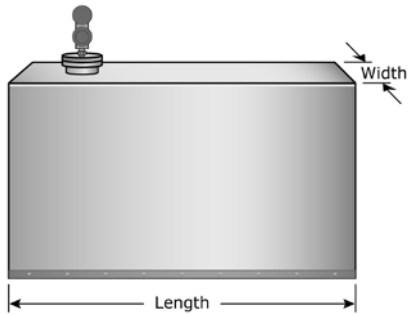

RECTANGULAR

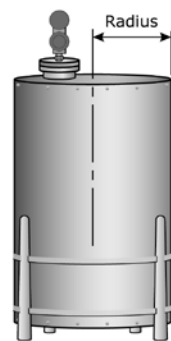

VERTICAL/FLAT

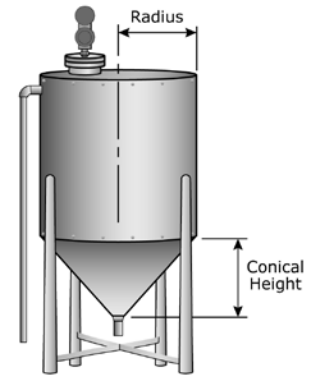

VERTICAL/CONICAL

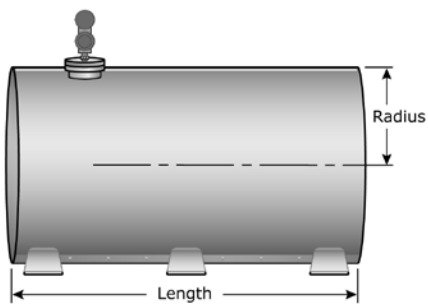

HORIZONTAL/FLAT

3.3.4.2 Configuration using Custom Table

If none of the nine *Vessel Types* shown can be used, a *Custom Table* can be created. A maximum of 30 points can be used to establish the level to volume relationship. The following table provides an explanation of each of the System Configuration parameters for volume applications where a Custom Table is needed.

Configuration Parameter	Explanation (Custom Volumetric Table)
Volume Units	A selection of Gallons, Barrels, Milliliters, Liters, Cubic Feet, Cubic Inches, or Cubic Meters is provided.
Vessel Type	Select Custom Table if none of the nine <i>Vessel Types</i> can be used.
Cust Table Type	The <i>Custom Table</i> points can be a Linear (straight line between adjacent points) or Spline (can be a curved line between points) relationship. See drawing below for more information.
Cust Table Vals	A maximum of 30 points can be used in building the <i>Custom Table</i> . Each pair of values will have a level (height) in the units chosen in the <i>Level Units</i> screen, and the associated volume for that level point. The values must be monotonic, i.e., each pair of values must be greater than the previous level/volume pair. The last pair of values should have the highest level value and volume value associated with the level in the vessel.

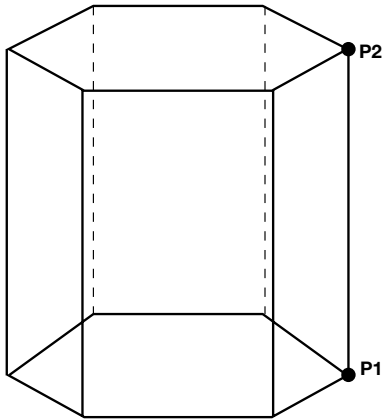

LINEAR

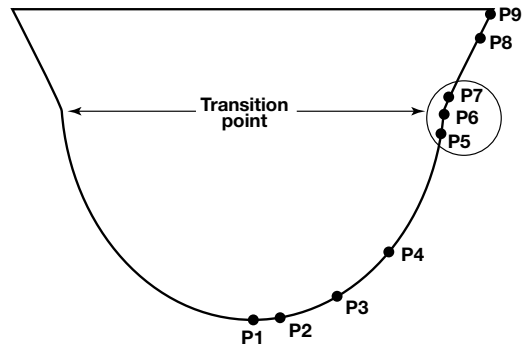

Use where walls are not perpendicular to base.

Concentrate at least two points at beginning (P1) and end (P9); and three points at either side of transition points.

SPLINE

3.3.5 Open Channel Flow Capability

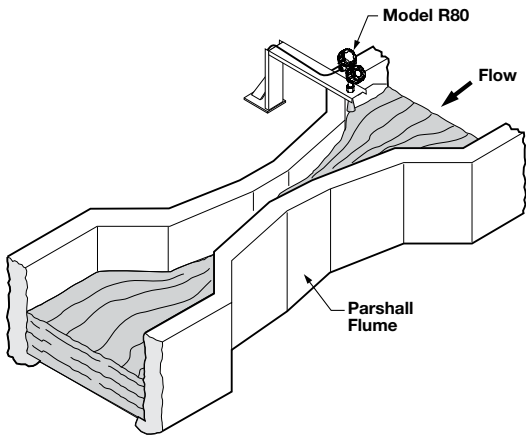

**Open Channel Flow Measurement
Parshall Flume**

Selecting Measurement Type = Flow allows the Pulsar Model R80 transmitter to measure flow as the Primary Measured Value.

Open channel flow is performed by using the Model R80 to measure the Head in a hydraulic structure. The hydraulic structure is the primary measuring element, of which the two most common types are weirs and flumes.

Since the primary element has a defined shape and dimensions, the rate of flow through the flume or over the weir is related to the Head at a specified measurement location.

The Model R80 is the secondary measuring device, which measures the Head of the liquid in the flume or weir. Open channel flow equations stored in the transmitter firmware convert the measured Head into units of flow (volume/time).

NOTE: Proper positioning of the Model R80 should be per the recommendation of the flume or weir manufacturer.

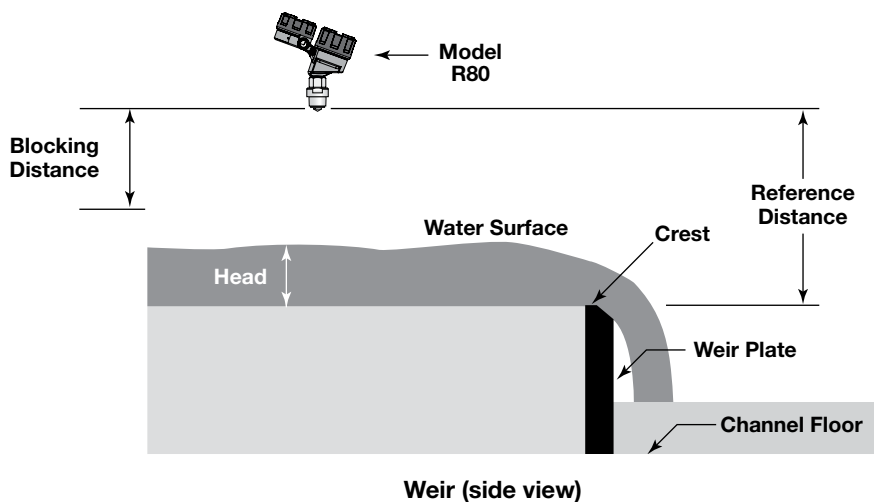
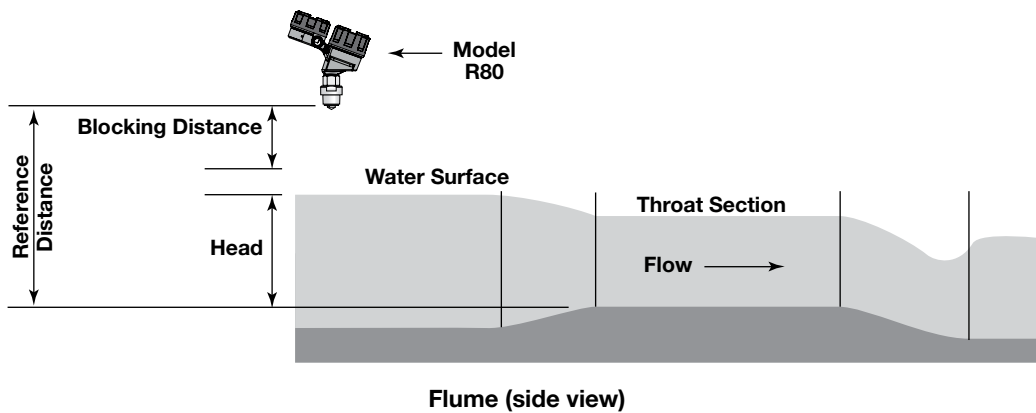

3.3.5.1 Configuration using Flume/Weir Equations

The following table provides an explanation of each of the System Configuration parameters required for open channel flow applications using one of the Flow Elements that are stored in the firmware.

Configuration Parameter	Explanation
Flow Units	A selection of Gallons/Minute (factory default <i>Flow Unit</i>), Gallons/Hour , Mil Gallons/Day , Liters/Second , Liters/Minute , Liters/Hour , Cubic Meter/Hour , Cubic Ft/Second , Cubic Ft/Minute , and Cubic Ft/Hour are provided.
Flow Element	Select one of the following primary Flow Elements that are stored in the firmware: Parshall flume sizes of 1", 2", 3", 6", 9", 12", 18", 24", 36", 48", 60", 72", 96", 120" and 144" . Palmer-Bwls (Palmer-Bowlus) flume sizes of 4", 6", 8", 10", 12", 15", 18", 21", 24", 27" and 30" . V-notch weir sizes of 22.5°, 30°, 45°, 60°, 90° and 120° . Rect with Ends (Rectangular Weir with End Contractions), Rect w/o Ends (Rectangular Weir without End Contractions), and Cipoletti weir. Custom Table (see page 43 can be selected if none of the stored <i>Flow Elements</i> can be used. The table can be built with a maximum of 30 points. The Model R80 also has the capability of using a Generic Equation (see page 42) for flow calculation.
Weir Crest Length	The <i>Weir Crest Length</i> screen only appears when the chosen <i>Flow Element</i> is Cipoletti or one of the <i>Rectangular</i> weirs. Input this length in the user-selected level units.
Flume Channel Width	Allows for entry of the width of the Palmer-Bowlus flume.
V-Notch Weir Angle	Appears only when flow element is V-Notch weir. It allows for the entry of angle of the V-Notch weir.
Reference Dist	The <i>Reference Distance</i> is measured from the sensor reference point to the point of zero flow in the weir or flume. This must be measured very accurately in the user-selected level units.
Maximum Head	<i>Maximum Head</i> is the highest liquid level (Head) value in the flume or weir before the flow equation is no longer valid. The <i>Maximum Head</i> is expressed in the user-selected <i>Level Units</i> . The Model R80 will default to the largest <i>Maximum Head</i> value that is allowed for any given flume or weir. The <i>Maximum Head</i> value can be revised depending on the value of the <i>Reference Distance</i> , or for end user preference.
Maximum Flow	<i>Maximum Flow</i> is a read-only value that represents the flow value corresponding to the <i>Maximum Head</i> value for the flume or weir.
Low Flow Cutoff	The <i>Low Flow Cutoff</i> (in user-selected level units) will force the calculated flow value to zero whenever the Head is below this point. This parameter will have a default and minimum value of zero.

3.3.5.2 Configuration using Generic Equation

The following table provides an explanation of each of the System Configuration parameters for Open channel flow applications using the Generic Equation.

Configuration Parameter	Explanation (Open Channel Flow – using the Generic Equation)
Flow Units	A selection of Gallons/Minute (factory default Flow Unit), Gallons/Hour , Mil Gallons/Day , Liters/Second , Liters/Minute , Liters/Hour , Cubic Meter/Hour , Cubic Ft/Second , Cubic Ft/Minute , and Cubic Ft/Hour are provided.
Flow Element	Select one of the following primary Flow Elements that are stored in the firmware: Parshall flume sizes of 1", 2", 3", 6", 9", 12", 18", 24", 36", 48", 60", 72", 96", 120" and 144" . Palmer-Bowlus flume sizes of 4", 6", 8", 10", 12", 15", 18", 21", 24", 27" and 30" . V-notch weir sizes of 22.5°, 30°, 45°, 60°, 90° and 120° . Rect with Ends (Rectangular Weir with End Contractions), Rect w/o Ends (Rectangular Weir without End Contractions), and Cipoletti weir. Custom Table (see page 43) can be selected if none of the stored <i>Flow Elements</i> can be used. The table can be built with a maximum of 30 points. The Model R80 also has the capability of using a Generic Equation (see below) for flow calculation.
Generic Eqn Factors	<i>Generic Equation</i> is a discharge flow equation in the form of $Q = K(L-CH)H^n$, where Q = flow (Cu Ft/Second), H = Head (Feet), K = a constant, and L, C and n are user input factors that depend on which <i>Flow Element</i> is being used. Make sure the flow equation is in the form of $Q = K(L-CH)H^n$, and proceed to enter the values of K,L,C,H and n. See example below. NOTE: The Generic Equation parameters must be entered in Cu Ft/Second units. The resultant flow is converted by the Model R80 into whatever Flow Units are selected above. See example below.
Reference Dist	The <i>Reference Distance</i> is measured from the sensor reference point to the point of zero flow in the weir or flume. This must be measured very accurately in the user-selected level units.
Maximum Head	<i>Maximum Head</i> is the highest liquid level (Head) value in the flume or weir before the flow equation is no longer valid. The <i>Maximum Head</i> is expressed in the user-selected level units. The Model R80 will default to the largest <i>Maximum Head</i> value that is allowed for any given flume or weir. The <i>Maximum Head</i> value can be revised depending on the value of the <i>Reference Distance</i> , or for end user preference.
Maximum Flow	<i>Maximum Flow</i> is a read-only value that represents the flow value corresponding to the <i>Maximum Head</i> value for the flume or weir.
Low Flow Cutoff	The <i>Low Flow Cutoff</i> (in user-selected level units) will force the calculated flow value to zero whenever the <i>Head</i> is below this point. This parameter will have a default and minimum value of zero.

Generic Equation Example (using equation for an 8' rectangular weir w/ end contractions)

Q = Cubic Ft/Second flow rate	L = 8' (weir crest length in feet)	H = Head value
K = 3.33 for Cubic Ft/Second units	C = 0.2 (constant)	n = 1.5 as an exponent

Using the factors above the equation becomes:

$$Q = K(L-CH)H^n$$

$$Q = 3.33 (8-0.2H) H^{1.5}$$

The discharge flow value for a Head value of three feet becomes 128.04 **Cubic Ft/Second**. If GPM was selected for the Flow Units, the Model R80 Measured Values screen would display this value converted to 57,490 GPM.

3.3.5.3 Configuration using Custom Table

Concentrate points as follows:

- A. At least two points at beginning (P1 and P2);
- B. At least two points at end (P9 and P10);
- C. Three points at approximate average flow rate (for example, P3, P4, P5); and at transition point (P7) and points on either side (P6, P8).

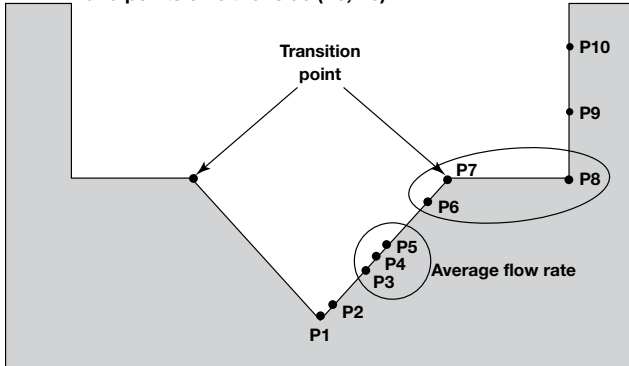

SPLINE

The following table provides an explanation of each of the System Configuration parameters for open channel flow applications using the Custom Table.

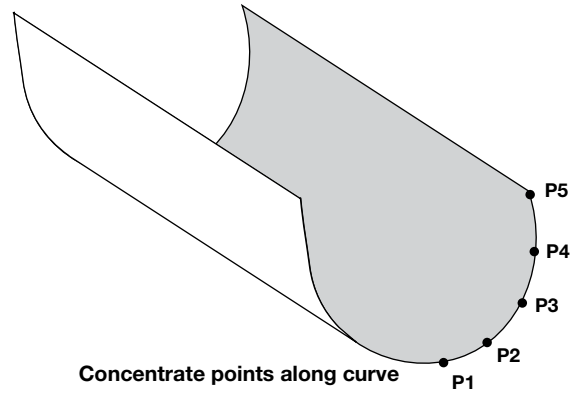

SPLINE OR LINEAR

Configuration Parameter	Explanation (Open Channel Flow – Custom Table)
Flow Units	A selection of Gallons/Minute (factory default Flow Unit), Gallons/Hour , Mil Gallons/Day , Liters/Second , Liters/Minute , Liters/Hour , Cubic Meters/Hour , Cubic Ft/Second , Cubic Ft/Minute , and Cubic Ft/Hour are provided.
Flow Element	Select one of the following primary Flow Elements that are stored in the firmware: Parshall flume sizes of 1", 2", 3", 6", 9", 12", 18", 24", 36", 48", 60", 72", 96", 120" and 144". Palmer-Bowlus flume sizes of 4", 6", 8", 10", 12", 15", 18", 21", 24", 27" and 30". V-notch weir sizes of 22.5°, 30°, 45°, 60°, 90° and 120°. Rect with Ends (Rectangular Weir with End Contractions), Rect w/o Ends (Rectangular Weir without End Contractions), and Cipoletti weir. Custom Table (see below) can be selected if none of the stored <i>Flow Elements</i> can be used. The table can be built with a maximum of 30 points. The Model R80 also has the capability of using a Generic Equation (see page 42) for flow calculation.
Custom Table	The <i>Custom Table</i> points can be a Linear (straight line between adjacent points) or Spline (can be a curved line between points) relationship. Refer to the drawing above for more information.
Cust Table Vals	A maximum of 30 points can be used in building the <i>Custom Table</i> . Each pair of values will have a Head (height) in the units chosen in the <i>Level Units</i> screen, and the associated flow for that Head value. The values must be monotonic, i.e., each pair of values must be greater than the previous Head/flow pair. The last pair of values should have the highest Head value (usually the <i>Maximum Head</i> value) and the flow associated with that Head value.
Reference Dist	The <i>Reference Distance</i> is measured from the sensor reference point to the point of zero flow in the weir or flume. This must be measured very accurately in the user-selected level units.
Maximum Head	<i>Maximum Head</i> is the highest liquid level (Head) value in the flume or weir before the flow equation is no longer valid. The <i>Maximum Head</i> is expressed in the user-selected <i>Level Units</i> . The Model R80 will default to the largest <i>Maximum Head</i> value that is allowed for any given flume or weir. The <i>Maximum Head</i> value can be revised depending on the value of the <i>Reference Distance</i> , or for end user preference.
Maximum Flow	<i>Maximum Flow</i> is a read-only value that represents the flow value corresponding to the <i>Maximum Head</i> value for the flume or weir.
Low Flow Cutoff	The Low Flow Cutoff (in user-selected level units) will force the calculated flow value to zero whenever the Head is below this point. This parameter will have a default and minimum value of zero.

3.4 Troubleshooting and Diagnostics

The Pulsar Model R80 transmitter is designed and engineered for trouble-free operation over a wide range of operating conditions. The transmitter continuously runs a series of internal self-tests and displays helpful messages on the large graphic liquid crystal display (LCD) when attention is required.

The combination of these internal tests and diagnostics messages offer a valuable proactive method of troubleshooting. The device not only tells the user what is wrong, but also, and more importantly, offers suggestions on how to solve the problem.

All of this information can be obtained directly from the transmitter on the LCD, or remotely by using a HART communicator or PACTware and the Pulsar Model R80 DTM.

PACTware™ PC Program

The Pulsar Model R80 offers the ability to perform more advanced diagnostics such as Trending and Echo Curve analysis using a DTM with PACTware. This is a powerful troubleshooting tool that can aid in the resolution of any diagnostic indicators that may appear.

Refer to Section 4.0, Advanced Configuration/ Troubleshooting Techniques for additional information.

3.4.1 Diagnostics (Namur NE 107)

The Pulsar Model R80 transmitter includes an exhaustive list of Diagnostic Indicators which follow the NAMUR NE 107 guidelines.

NAMUR is an international user association of automation technology in process industries, whose goal is to promote the interest of the process industry by pooling experiences among its member companies. In doing so, this group promotes international standards for devices, systems, and technologies.

The objective of NAMUR NE 107 was essentially to make maintenance more efficient by standardizing diagnostics information from field devices. This was initially integrated via Foundation fieldbus, but the concept applies regardless of the communication protocol.

According to the NAMUR NE107 recommendation, "Self Monitoring and Diagnosis of Field Devices," fieldbus diagnostic results should be reliable and viewed in the context of a given application. The document recommends categorizing internal diagnostics into four standard status signals:

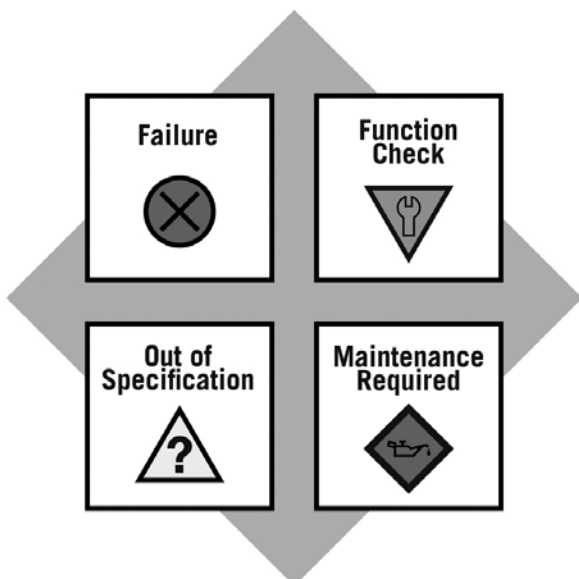

- Failure
- Function Check
- Out of Specification
- Maintenance required

These categories are shown by both symbols and colors, depending on the display capability.

In essence, this approach ensures that the correct diagnostic information is available to the correct person-at the correct time. In addition, it allows diagnostics to be applied, as most appropriate, for a particular plant application (such as process control engineering or asset management maintenance). Customer specific mapping of diagnostics to these categories allows for flexible configuration depending on the user's requirements.

From an external Model R80 transmitter perspective, diagnostic information includes measurement of process conditions, in addition to detection of internal device or system anomalies.

As mentioned above, the indicators can be assignable (via the a DTM or host system) by the user to any (or none) of the NAMUR recommended Status Signal categories: Failure, Function Check, Out of Specification, and Maintenance Required.

Indicators that are mapped to the Failure category will normally result in a current loop alarm output. The alarm state for HART transmitters is configurable as high (22 mA), Low (3.6 mA), or Hold (last value).

Users will not have the ability to unassign certain indicators from the Failure signal category as the Model R80 user interfaces will prohibit or reject such re-assignment entries. This is to ensure that current loop alarms are asserted in situations where the device is not able to provide measurements due to critical failures. (For example, if the alarm selection has not been set to Hold or a fixed current mode is in effect.)

A default mapping of all diagnostic indicators will be applied initially, and can be re-applied through use of a reset function.

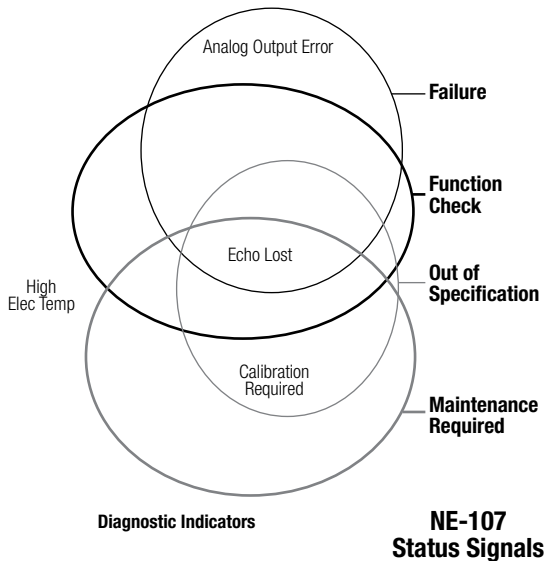

Refer to the Diagnostic Indicator tables in this section for a complete listing of the Model R80 diagnostic indicators, along with their explanations, default categories, and recommended remedies.

- NOTES: 1) The remedies shown in this table can also be seen on the transmitter LCD by viewing the present status screen when the device is in a diagnostic condition.
- 2) Those indicators showing failure as the default result in an alarm condition.

3.4.2 Diagnostic Indication Simulation

The DD and DTM allow for the ability to manipulate diagnostic indicators. Intended as a means to verify the configuration of the diagnostic parameters and connected equipment, a user can manually change any indicator to and from the active state.

3.4.3 Diagnostic Help

Selecting DIAGNOSTICS from the MAIN MENU presents a list of five ITEMS from the top level of the DIAGNOSTICS tree.

When Present Status is highlighted, the highest priority active diagnostic indicator (numerically lowest in Table 3.4) is displayed on the bottom LCD line. Pressing the ENTER key moves the active diagnostic indicator to the top line outdented and presents in the lower area of the LCD a brief explanation of and possible remedies for the indicated condition. A blank line separates the explanation from the remedies. Additional active diagnostic indicators, if any, appear with their explanations in descending priority order. Each additional active indicator name-explanation pair is separated by a blank line from the one above.

If the explanation and remedy text (and additional name-explanation pairs) exceeds the available space, a ⏴ appears in the rightmost column of the last line indicating more text below. In this situation, the DN key scrolls text up one line at a time. Similarly, while text exists above the upper line of the text field, a ⏵ appears in the rightmost column of the top (text) line. In this situation, the UP key scrolls the text down one line at a time. Otherwise the DN and UP keys are inoperative. In all cases the ENT or DEL key reverts to the previous screen.



When the transmitter is operating normally and the highlight cursor is positioned on Present Status, the bottom LCD line displays “OK” because no diagnostic indicators are active.

EVENT HISTORY – This menu displays the last twenty events related to configuration and diagnostic event logging.

ADVANCED DIAGNOSTICS – This menu displays parameters related to some of the advanced diagnostics available within the Model R80.

INTERNAL VALUES – Displays read-only internal parameters.

ELEC TEMPERATURES – Displays temperature information as measured in the electronics module in degrees C or F.

TRANSMITTER TESTS – Allows the user to manually set the output current to a constant value. This is a method for the user to verify operation of the other equipment in the loop.

ECHO CURVES – This menu allows the user to display the live Echo Curve, Echo Reference Curve, Echo History Curves, or Echo Rejection Curve on the LCD.

3.4.4 Diagnostic Indicator Table

Shown below and at right is a listing of the Model R80 diagnostic indicators, showing their priority, explanations and recommended remedies. (Priority 1 is highest priority.)

Priority	Indicator Name	Default Category	Explanation	Explanation
1	Software Error	Failure	Unrecoverable error occurred in stored program.	Contact Technical Support
2	RAM Error	Failure	RAM (read/write) memory failing.	
3	ADC Error	Failure	Analog-to-digital converter failure.	
4	EEPROM Error	Failure	Non-volatile parameter storage failing.	
5	Firmware Conflict	Failure	Unrecoverable hardware failure.	
6	Analog Output Error	Failure	Actual loop current deviates from commanded value. Analog output is inaccurate.	Perform Adjust Analog Output maintenance procedure.
7	Coprocessor Error	Failure	Unrecoverable hardware error	Contact Technical Support.
8	Default Parameters		Saved parameters are set to default values.	Perform complete Device Configuration.
9	Spare Indicator 1	OK	Reserved for future use.	
10	Spare Indicator 2	OK	Reserved for future use.	
11	Spare Indicator 3	OK	Reserved for future use.	
12	Too Many Echoes	Failure	Excessive number of possible echoes detected	Check Settings: Dielectric, Sensitivity. Check Polarization.
13	Safety Zone Alarm	Failure	Risk of echo loss if liquid rises above Blocking Distance.	Ensure that liquid cannot reach Blocking Distance.
14	Echo Lost	Failure	No signal detected.	Check settings: Dielectric Range Increase Sensitivity. View Echo Curve.
15	Spare Indicator 4	OK	Reserved for future use	
16	Config Conflict	Failure	Measurement type and primary variable selection parameters are inconsistent.	Confirm proper configuration. Check Measurement Type.
17	High Volume Alarm	Failure	Volume calculated from Level reading exceeds capacity of vessel or custom table.	Check settings: Vessel Dimensions, Custom Table entries
18	High Flow Alarm	Failure	Calculated flow exceeds maximum for flume or custom table.	Check settings: Vessel Dimensions, Custom Table entries
19	No Moving Echo	OK	No moving echoes have been detected or selected	
20	Initializing	Function Check	Distance measurement is inaccurate while internal filters are settling.	Standard start-up message. Wait for up to 10 seconds.

Priority	Indicator Name	Default Category	Explanation	Explanation
21	Config Changed	Function Check	A parameter has been modified from the User Interface.	If desired, reset Config Changed indicator in ADVANCED CONFIG menu.
22	Spare Indicator 5	OK	Reserved for future use.	
23	High Elec Temp	Out of Spec	Electronics too hot. May compromise level measurement or damage instrument.	Shield transmitter from heat source or increase air circulation. Locate transmitter remotely in a cooler area.
24	Low Elec Temp	Out of Spec	Electronics too cold. May compromise level measurement or damage instrument.	Insulate transmitter.
25	Calibration Req'd	Out of Spec	Factory calibration has been lost. Measurement accuracy may be diminished.	Locate transmitter remotely in a warmer area.
26	Echo Reject Invalid	Out of Spec	Echo Rejection inoperative. May report erroneous Level readings. Upr Echo may be lost.	Return transmitter to factory for recalibration.
27	Spare Indicator 6	OK	Reserved for future use.	
28	Inferred Level	Out of Spec	Level inferred to have entered Blocking Region if echo lost within Max Distance Jump of Top or Bottom Blocking Region.	Verify level reading; if incorrect, check configuration.
29	Adjust Analog Out	Out of Spec	Loop current is inaccurate.	Perform Adjust Analog Output maintenance procedure.
30	Totalizer Data Lost		Totalizer data has been lost; restarted from zero.	
31	Low Supply Voltage	Out of Spec	Loop current may be incorrect at higher values. Analog output is inaccurate.	Verify loop resistance. Replace loop power supply.
32	Spare Indicator 7	OK	Reserved for future use.	
33	Max Jump Exceeded	Maintenance Required	Transmitter has jumped to an echo at location that exceeds "Max Level Jump" from previous echo location.	Check settings: Dielectric Range Sensitivity View Echo Curve.
34	Low Echo Margin	Maintenance Required	Signal Margin is less than allowable minimum.	Check settings: Dielectric Range Sensitivity View Echo Curve.
35	High Surface Velocity	Maintenance Required	Measured Surface Velocity greater than Max Surface Velocity derived from configured Rate of Change.	Confirm actual rate of change. Adjust rate of change setting, if needed.
36	Spare Indicator 8	OK	Reserved for future use.	
37	Sequence Record	OK	A Sequence Record number has been stored in Event Log.	If desired, report Sequence Record number to factory.

3.4.5 Additional Diagnostic/Trouble Shooting Capabilities

3.4.5.1 Echo History Setup

The Model R80 contains the unique and powerful feature that allows waveforms to be automatically captured based on Diagnostic Events, Time or both. This menu contains those parameters that configure that feature.

Eleven (11) waveforms can be saved directly into the transmitter.

- Nine (9) Troubleshooting Curves
- One (1) Echo Rejection Curve
- One (1) Reference Curve

3.4.5.2 Event History

As a means for improved troubleshooting capability, a record of significant diagnostic events is stored with time and date stamps. A real-time on-board clock (which must be set by the operator), will maintain the current time.

3.4.5.3 Context-sensitive Help

NOTE: Context-sensitive HELP is available for all menu items. With the menu item highlighted, hold down the ENTER key for two seconds. Use UP and DOWN for navigation.

Descriptive information relevant to the highlighted parameter in the menu will be accessible via the local display and remote host interfaces. This will most often be a parameter-related screen, but could also be information about menus, actions (for example, Loop [Analog Output] Test, resets of various types), diagnostic indicators, etc.

For example: Dielectric Range — Selects the range bounding the dielectric constant of the medium in vessel. Some ranges may not be selectable depending on the antenna model.

3.4.5.4 Trend Data

Another feature of the Model R80 is the ability to log several measured values (selectable from any of the primary, secondary, or supplemental measured values) at a configurable rate (for example, once every five minutes) for a period ranging from several hours to a number of days (depending on the configured sample rate and number of values to be recorded). The data will be stored in non-volatile memory in the transmitter with date and time information for subsequent retrieval and visualization using the associated Model R80 DTM.

TREND DATA – A 15-minute trend of the PV can be displayed on the LCD.

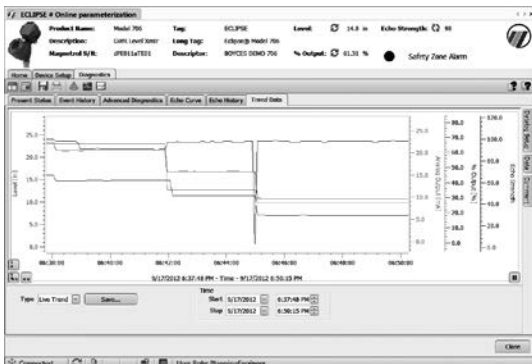

3.5 Agency Approvals



These devices are in compliance with the RED-directive 2014/53/EU, the EMC directive 2014/30/EU, the PED-directive 2014/68/EU, the ATEX directive 2014/34/EU and RoHS directive 2011/65/EU.

705 ENTERPRISE ST AURORA, 60504 IL USA

PULSAR®

MODEL: _____

SERIAL: _____

XP-IS
FM21US0091X / FM21CA0059X
CL I, DIV 1, GP B,C,D,T4...T3
CL I, ZONE 0/1 AEx/Ex ia/ db IIB + H2 T4...T3 Ga/Gb
Ta = -40°C to +70°C
TYPE 4X, IP67

FM21ATEX0058X / FM21UKEX0191X
II 1/2 G Ex ia/ db IIB + H2 T4...T3 Ga/Gb
II 2 G Ex db ia IIB + H2 T4...T3 Gb
Ta = -40°C to +70°C
IP67

FOR US/CANADA DIVISIONS: INSTALL SEAL WITHIN 18 INCHES / UN SCELLEMENT DOIT ETRE INSTALLE A MOINS DE 18 INCHES DU BOITIER
FOR CANADA ZONES: INSTALL SEAL WITHIN 50MM / UN SCELLEMENT DOIT ETRE INSTALLE A MOINS DE 50 MM DU BOITIER

MANF YEAR: _____

INPUT: Um=36V

OUTPUT: 4-20mA

THREADED ENTRY: _____

MAX PRESS: _____

REFER TO INSTRUCTION MANUAL

Explosion/Flame Proof - Intrinsically Safe

705 ENTERPRISE ST AURORA, 60504 IL USA

PULSAR®

MODEL: _____

SERIAL: _____

IS
FM21US0091X / FM21CA0059X
CL I, II, III, DIV 1, GP A,B,C,D,E,F,G T4...T3
CL I, ZONE 0 AEx/Ex ia IIC T4...T3 Gc
CL I, ZONE 2 AEx/Ex ic IIC T4...T3 Gc
Ta = -40°C to +70°C
TYPE 4X, IP67

FM21ATEX0058X / FM21UKEX0191X
II 1 G Ex ia IIC T4...T3 Gc
Ta = -40°C to +70°C
IP67

MANF YEAR: _____

THREADED ENTRY: _____

MAX PRESS: _____

REFER TO INSTRUCTION MANUAL

ENTITY
Ui(Vmax)=28.6V li(Imax)=140mA
Pi=1W Ci=4.4nF Li=2.7uH

Intrinsically Safe

705 ENTERPRISE ST AURORA, 60504 IL USA

PULSAR®

MODEL: _____

SERIAL: _____

DIP-IS
FM21US0091X / FM21CA0059X
CL II, III, DIV 1, GP E,F,G T4...T3
Ta = -15°C to +70°C
TYPE 4X, IP67

FM21ATEX0058X / FM21UKEX0191X
II 2 D Ex ia tb IIC T100°C Db
Ta = -15°C to +70°C
IP67

MANF YEAR: _____

INPUT: Um=36V

OUTPUT: 4-20mA

THREADED ENTRY: _____

MAX PRESS: _____

REFER TO INSTRUCTION MANUAL

Dust Ignition Proof

705 ENTERPRISE ST AURORA, 60504 IL USA

PULSAR®

MODEL: _____

SERIAL: _____

AEx/Ex ec Ta = -15°C to +70°C
Ta = -40°C to +70°C

FM21ATEX0059X / FM21UKEX0192X
II 3 G Ex ec IIC T4...T3 Gc
II 3 G Ex ic IIC T4...T3 Gc
IP67

MANF YEAR: _____

INPUT: Um=36V

OUTPUT: 4-20mA

THREADED ENTRY: _____

MAX PRESS: _____

REFER TO INSTRUCTION MANUAL

Non-Incendive, Increased Safety

SPECIAL CONDITIONS OF USE:

1. The enclosure contains aluminium and is considered to present a potential risk of ignition by impact or friction. Care must be taken during installation and use to prevent impact or friction.
2. The transmitter shall be connected to a safety extra low-voltage circuit (SELV) with Um ≤ 36V
3. To maintain the T4...T3 temperature code care shall be taken to ensure the enclosure temperature does not exceed 70°C.
4. For Installation with ambient temperature of 60°C, refer to the manufacturer's instructions for guidance on proper selection of conductors.
5. The risk of electrostatic discharge shall be minimized at installation, following the direction given in the instruction manual.
6. The Pulsar R80 includes flamepath joints, consult Magnetrol if repair of the flamepath joints is necessary.
7. Temperature class for the process temperature ranges is defined by the following table:

Process Temperature Range	Temperature Code
From 0 to 95 °C	T4
From 130 to 195 °C	T3

This equipment with chargeable non-conductive parts, e.g. enclosure's paint and antenna use PTFE, Co-polymer Polypropylene or Noryl En265, is provided with a warning label referring to the safety measures that must be taken if there is electrostatic charging during operation. For use in hazardous area, the equipment and side to be installed, e.g. tank, must be connected to earth and be attention to not only the measuring object, e.g., liquids, gases, powders and etc., but also the related conditions, e.g. tank container, vessel and etc. (According to IEC 60079- 32-1).

Telecommunications Approvals

Agency	In-Tank	Out of Tank
FCC	47 CFR, Part 15, Subpart C, Section 15.209 Unintentional Radiators	47 CFR, Part 15, Subpart C, Section 15.256
ISED	RSS-211	RSS-211
ETSI	EN 302 372 V2.1.1 (2016-12)	EN 302 729 V2.1.1 (2016-12)

FCC/ISED TLPR Use Configurations for Enclosed Tank Applications Only				
Antenna Type	Frequency Band (GHz)	Reinforced Fiberglass Tank	Concrete Tank	Metal Tank
¾"	77 to 81	Allowed	Allowed	Allowed
1½"	77 to 81	Allowed	Allowed	Allowed
2"	77 to 81	Allowed	Allowed	Allowed
3"	77 to 81	Allowed	Allowed	Allowed

FCC/ISED LPR Use Configurations		
Antenna Type	Frequency Band (GHz)	Open Air / Tank
2"	77 to 81	Allowed
3"	77 to 81	Allowed

ISED:

The installation of the LPR/TLPR device shall be done by trained installers, in strict compliance with the manufacturer's instructions.

The use of this device is on a "no-interference, no-protection" basis. That is, the user shall accept operations of high-powered radar in the same frequency band which may interfere with or damage this device. However, devices found to interfere with primary licensing operations will be required to be removed at the user's expense.

The installer/user of this device shall ensure that it is at least 10 km from the Dominion Astrophysical Radio Observatory (DRAO) near Penticton, British Columbia.

The coordinates of the DRAO are latitude 49°19'15" N and longitude 119°37'12" W. For devices not meeting this 10 km separation (e.g., those in the Okanagan Valley, British Columbia), the installer/user must coordinate with, and obtain the written concurrence of, the Director of the DRAO before the equipment can be installed or operated. The Director of the DRAO may be contacted at 250-497-2300 (tel) or 250-497-2355 (fax). (Alternatively, the Manager, Regulatory Standards, Industry Canada, may be contacted.)

L'installation du dispositif LPR/TLPR doit être effectuée par des installateurs formés, dans le strict respect des instructions du fabricant.

L'utilisation de cet appareil se fait sur une base « sans interférence, sans protection ». C'est-à-dire que l'utilisateur doit accepter les opérations d'un radar de grande puissance dans le même bande de fréquence qui peut interférer ou endommager cet appareil. Cependant, les appareils qui interfèrent avec les opérations de licence primaires doivent être retirés aux frais de l'utilisateur.

L'installateur/l'utilisateur de cet appareil doit s'assurer qu'il se trouve à au moins 10 km du Dominion Astrophysical Radio Observatory (DRAO) près de Penticton, Colombie britannique.

Les coordonnées du DRAO sont la latitude 49°19'15" N et la longitude 119°37'12" W. Pour les appareils ne respectant pas cette séparation de 10 km (par exemple, ceux dans la vallée de l'Okanagan, en Colombie-Britannique), l'installateur/l'utilisateur doit se coordonner avec le directeur du DRAO avant que l'équipement puisse être installé ou utilisé. Le directeur de la DRAO peut être contacté au 250-497-2300 (tél) ou au 250-497-2355 (fax). (Vous pouvez également communiquer avec le gestionnaire, Normes réglementaires, Industrie Canada.)

ISED- TLPR device:

This device shall be installed and operated in a completely enclosed container to prevent RF emissions, which can otherwise interfere with aeronautical navigation.

Cet appareil doit être installé et utilisé dans un conteneur complètement fermé pour éviter les émissions RF, qui peuvent autrement interférer avec les la navigation.

FCC- TLPR device:

This device may only be operated in the type of enclosures for which it was approved.

TLPR configurations are not allowed in open-air environments.

FCC and ISED-LPR tank limitations under 15.256 and RSS-211:

The LPR may only be operated in the type of enclosure(s), and with the antenna(s), for which it was approved.

The LPR device shall be installed and maintained to ensure a vertically downward orientation of the transmit antenna's main beam.

The LPR device shall be installed only at fixed locations.

The LPR device shall not operate while being moved, or while inside a moving container.

Hand-held applications are prohibited.

Marketing to residential consumers is prohibited.

§15.105 Information to the user

(b) For a Class B digital device or peripheral, the instructions furnished the user shall include the following or similar statement, placed in a prominent location in the text of the manual:

Note: This equipment has been tested and found to comply with the limits for a Class B digital device, pursuant to part 15 of the FCC Rules. These limits are designed to provide reasonable protection against harmful interference in a residential installation. This equipment generates, uses and can radiate radio frequency energy and, if not installed and used in accordance with the instructions, may cause harmful interference to radio communications. However, there is no guarantee that interference will not occur in a particular installation. If this equipment does cause harmful interference to radio or television reception, which can be determined by turning the equipment off and on, the user is encouraged to try to correct the interference by one or more of the following measures:

- Reorient or relocate the receiving antenna.
- Increase the separation between the equipment and receiver.
- Connect the equipment into an outlet on a circuit different from that to which the receiver is connected.
- Consult the dealer or an experienced radio/TV technician for help.

(i) The installation of the LPR/TLPR device shall be done by trained installers, in strict compliance with the manufacturer's instructions.

(ii) The use of this device is on a "no-interference, no-protection" basis. That is, the user shall accept operations of high-powered radar in the same frequency band which may interfere with or damage this device. However, devices found to interfere with primary licensing operations will be required to be removed at the user's expense.

Changes or modifications not expressly approved by the manufacturer could void the user's authority to operate the equipment.

This device contains licence-exempt transmitter(s)/receiver(s) that comply with Innovation, Science and Economic Development Canada's licence-exempt RSS(s). Operation is subject to the following two conditions:

1. This device may not cause interference.
2. This device must accept any interference, including interference that may cause undesired operation of the device.

Cet appareil contient des émetteurs / récepteurs exempts de licence qui sont conformes aux RSS exemptes de licence d'Innovation, Sciences et Développement économique Canada. Son fonctionnement est soumis aux deux conditions suivantes: Cet appareil ne doit pas provoquer d'interférences. Cet appareil doit accepter toutes les interférences, y compris les interférences susceptibles d'entraîner un fonctionnement indésirable de l'appareil.

The installation requirements of Tank Level Probing Radar equipment to ensure a proper shielding.

Annex E:

The following installation requirements shall be fulfilled:

- a) TLPR are required to be installed at a permanent fixed position at a closed (not open) metallic tank or reinforced concrete tank, or similar enclosure structure made of comparable attenuating material;
- b) flanges and attachments of the TLPR equipment shall provide the necessary microwave sealing by design;
- c) sight glasses shall be coated with a microwave-proof coating when necessary (i.e., electrically conductive coating);
- d) manholes or connection flanges at the tank shall be closed to ensure a low-level leakage of the signal into the air outside the tank;
- e) whenever possible, mounting of the TLPR equipment shall be on top of the tank structure with the orientation of the antenna to point in a downward direction;
- f) installation and maintenance of the TLPR equipment shall be performed by professionally trained individuals only.

The provider is required to inform the users and installers of the TLPR equipment about the installation requirements and, if applicable, the additional special mounting instructions (e.g., by putting it in the product manual).

3.5.1 Agency Drawing and Entity Parameters

HAZARDOUS LOCATION

PULSAR R80 LEVEL TRANSMITTER

INTRINSICALLY SAFE FOR:

CL I,II,III DIV 1 GRP A,B,C,D,E,F,G

CL I, ZONE 0 AEx ia IIC

CL I, ZONE 0 Ex ia IIC

II 1 G Ex ia IIC

Ex ia IIC

CL I Zone 2 AEx ic IIC

CL I Zone 2 Ex ic IIC

II 3 Ex ic IIC

Ex ic IIC

ENTITY

Ui (Vmax) = 28.6 V

Ii (Imax) = 140 mA

Pi = 1 W

Ci = 4.4nF

Li = 2.7 μH

NON-HAZARDOUS LOCATION

LIMITING VALUES

Voc <= 28.6V

Ca >= 4.4 nF

Isc <= 140 mA

La >= 2.7μH

THE VOLTAGE (V max) AND CURRENT (I max), WHICH THE TRANSMITTER CAN RECEIVE MUST BE EQUAL TO OR GREATER THAN THE MAXIMUM OPEN CIRCUIT VOLTAGE (Voc OR V+) AND THE MAXIMUM SHORT CIRCUIT CURRENT (Isc OR IE), WHICH CAN BE DELIVERED BY THE SOURCE DEVICE. IN ADDITION, THE MAXIMUM CAPACITANCE (Ci) AND INDUCTANCE (Li) OF THE LOAD AND THE CAPACITANCE AND INDUCTANCE OF THE INTERCONNECTING WIRING, MUST BE EQUAL TO LESS THAN THE CAPACITANCE (Ca) OR THE INDUCTANCE (La), WHICH CAN BE DRIVEN BY THE SOURCE DEVICE.

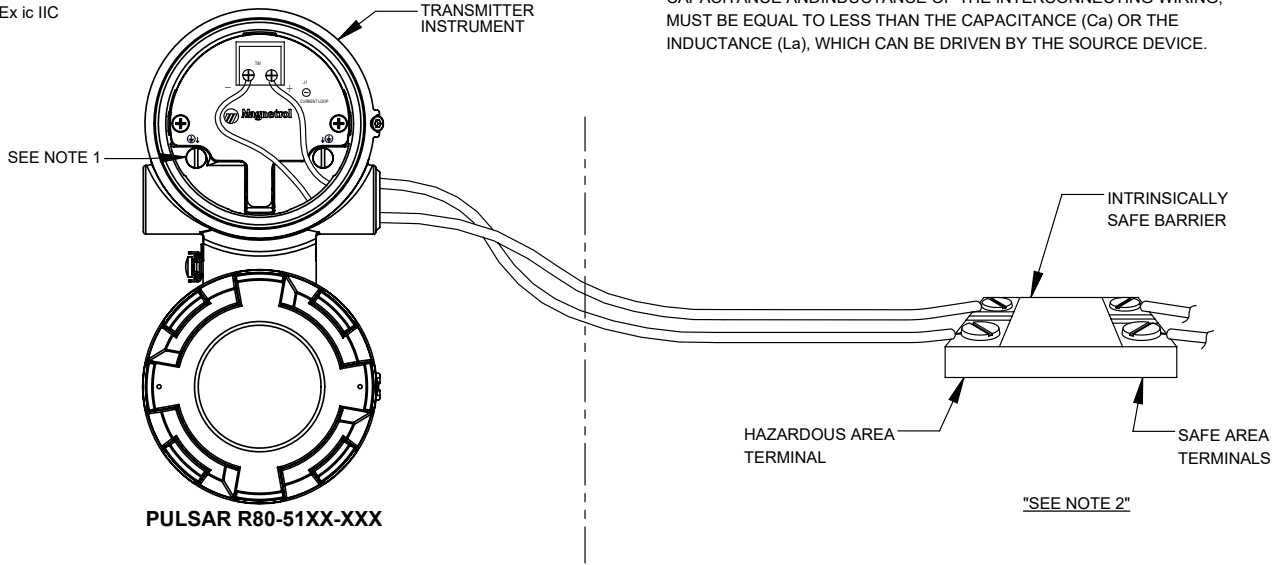

SPECIFIC CONDITIONS OF USE:

1. THE ENCLOSURE CONTAINS ALUMINUM AND IS CONSIDERED TO PRESENT A POTENTIAL RISK OF IGNITION BY IMPACT OR FRICTION. CARE MUST BE TAKEN DURING INSTALLATION AND USE TO PREVENT IMPACT OR FRICTION.
2. THE TRANSMITTER SHALL BE CONNECTED TO A SAFETY EXTRA LOW-VOLTAGE CIRCUIT (SELV) WITH $U_m = \leq 36V$.
3. TO MAINTAIN THE T4...T3 TEMPERATURE CODE CARE SHALL BE TAKEN TO ENSURE THE "ENCLOSURE TEMPERATURE" DOES NOT EXCEED 70°C.
4. FOR INSTALLATION WITH AMBIENT TEMPERATURE OF 60°C, REFER TO THE MANUFACTURER'S INSTRUCTIONS FOR GUIDANCE ON PROPER SELECTION OF CONDUCTORS.
5. THE RISK OF ELECTROSTATIC DISCHARGE SHALL BE MINIMIZED AT INSTALLATION, FOLLOWING THE DIRECTION GIVEN IN THE INSTRUCTION MANUAL.
6. THE PULSAR R80 INCLUDES FLAMEPATH JOINTS, CONSULT MAGNETROL IF REPAIR OF FLAMEPATH JOINTS IS NECESSARY.
7. TEMPERATURE CLASS FOR THE PROCESS TEMPERATURE RANGES IS DEFINED BY THE FOLLOWING TABLE.

PROCESS TEMPERATURE RANGE	TEMPERATURE CODE
FROM 0°C TO 130°C	T4
FROM 130°C TO 195°C	T3

NOTES:

1. FOR EXPLOSION PROOF INSTALLATIONS THE I.S. GROUND TERMINAL SHALL BE CONNECTED TO APPROPRIATE INTRINSICALLY SAFE GROUND IN ACCORDANCE WITH THE CANADIAN ELECTRICAL CODE (CEC) OR THE NATIONAL ELECTRICAL CODE (NEC). FOR INTRINSICALLY SAFE INSTALLATIONS THE I.S. GROUND TERMINAL DOES NOT REQUIRE GROUNDING.
2. MANUFACTURER'S INSTALLATION INSTRUCTIONS SUPPLIED WITH THE PROTECTIVE BARRIER AND THE CEC OR THE NEC MUST BE FOLLOWED WHEN INSTALLING THIS EQUIPMENT. BARRIER MUST BE CERTIFIED FOR CANADIAN & U.S. INSTALLATION.
3. CONTROL EQUIPMENT CONNECTED TO PROTECTIVE BARRIERS MUST NOT USE OR GENERATE MORE THAN 250 VDC OR VRMS.
4. AGENCY APPROVED DUST TIGHT SEALS MUST BE USED WHEN TRANSMITTER IS INSTALLED IN CLASS II & III ENVIRONMENTS.
5. FOR SUPPLY CONNECTIONS, USE WIRE SUITABLE FOR THE OPERATING TEMPERATURE.
6. FM APPROVED BARRIERS WITH LINEAR OUTPUT CHARACTERISTICS MUST BE USED.

099-5082-A

3.6 Specifications

3.6.1 Functional/physical

System Design

Measurement Principle Frequency Modulated Continuous Wave (FMCW) Radar 80 GHz

Input

Measured Variable Level, determined by the difference in modulated frequencies

Span 0.2 to 30 meters (0.5 to 100 feet)

Output

Type 4–20 mA with HART: 3.8 mA to 20.5 mA useable (per NAMUR NE43)

Resolution Analog: .003 mA / Digital Display: 1 mm

Loop Resistance GP/IS: 590 ohms @ 24 VDC and 22 mA

XP/Flameproof: 500 ohms @ 24 VDC and 22 mA

Diagnostic Alarm Selectable: 3.6 mA, 22 mA (meets requirements of NAMUR NE 43), or HOLD last output

Diagnostic Indication Meets requirements of Namur NE107

Damping Adjustable 0–10 seconds

User Interface

Keypad 4-button menu-driven data entry

Display Graphic Liquid Crystal Display

Digital Communication HART ver. 7–w/ Field Communicator, AMS, or FDT DTM (PACTware™), FDI/EDDL

Menu Languages Transmitter LCD: English, French, German, Spanish, Russian, Portuguese, Polish

HART DD: English, French, German, Spanish, Russian, Chinese, Portuguese, Polish

Voltage (Measured at instrument terminals) HART: General Purpose (Weather proof)/Intrinsically Safe/Explosion-proof: 11 VDC minimum at terminals under certain conditions (refer to Manual 58-604)

Housing

Material IP67/die-cast aluminum A413 (<0.6% copper); optional stainless steel

Net/Gross Weight Aluminum: 2.0 kg (4.5 lbs.) / Stainless Steel: 4.50 kg (10.0 lbs.)

Cable Entry ½" NPT or M20

SIL 2 Hardware (Safety Integrity Level) Safe Failure Fraction = 92.3% (HART only); Functional Safety to SIL 2 as 1oo1 in accordance with IEC 61508 (Full FMEDA report available upon request)

3.6.2 Environment

Ambient Operating Temperature -40 to +160 °F (-40 to +70 °C); LCD viewable -20 to +70 °C (-5 to +160 °F)

Storage Temperature -45 to +85 °C (-50 to +185 °F)

Humidity 0–99%, non-condensing

Electromagnetic Compatibility Meets CE requirement (EN 61326) and NAMUR NE 21

Surge Protection Meets CE EN 61326 (1000V)

Shock/Vibration ANSI/ISA-S71.03 Class SA1 (Shock); ANSI/ISA-S71.03 Class VC2 (Vibration)

3.6 Specifications

3.6.3 Performance

Reference Conditions	Reflection from ideal reflector at +20 °C (+70 °F)
Linearity	≤ 1mm
Measured Error	≤ 1mm (Performance will degrade slightly within 25 cm (10") of antenna)
Resolution	0.1 inch or 1mm
Repeatability	≤ 1mm
Response Time	< 3 seconds (configuration dependent)
Initialization Time	< 30 seconds (configuration dependent)
Ambient Temperature Effect	Digital: < 3 mm/10 K, 10 mm maximum Analog: < 0.03 %/10 K or 0.3 % maximum relating to the 16.7 mA span)
Maximum Rate of Change	450 cm (180 inches)/minute

3.6.3.1 Safe operating Areas

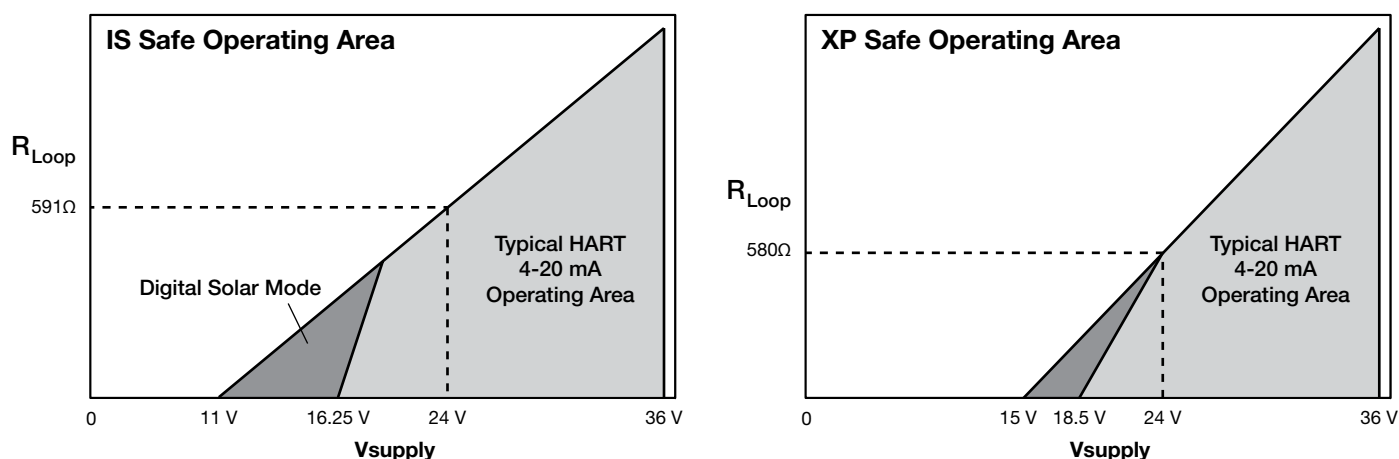

3.6.3.2 Transmitter Terminal Voltage

Operational Mode	Current Consumption	Vmin	Vmax
HART			
General Purpose	4mA	16.25V	36V
	20mA	11V	36V
Intrinsically Safe	4mA	16.25V	28.6V
	20mA	11V	28.6V
Explosion Proof	4mA	18.5V	36V
	20mA	15V	36V
Fixed Current-Solar Power Operation (PV transmitter via HART)			
General Purpose	10mA ①	11V	36V
Intrinsically Safe	10mA ①	11V	28.6V
HART Multi-Drop Mode (Fixed Current)			
Standard	4mA ①	16.25V	36V
Intrinsically Safe	4mA ①	16.25V	28.6V

① Start-up current 12 mA minimum

3.6.4 O-ring (seal) Selection Chart

Material	Code	Maximum Temperature	Maximum Pressure	Min. Temp.	Recommended For Use In	Not Recommended For Use In
Viton® VX065	0	① +200 °C @ 16 bar (+400 °F @ 232 psi)	70 bar @ +20 °C (1000 psi @ +70 °F)	-40 °C (-40 °F)	General purpose, ethylene	Ketones (MEK, acetone), skydrol fluids, amines, anhydrous ammonia, low molecular weight esters and ethers, hot hydrofluoric or chlorosulfuric acids, sour HCs
Kalrez® 4079	2	200 °C @ 16 bar+ (+400 °F @ 232 psi)	70 bar @ +20 °C (1000 psi @ +70 °F)	-40 °C (-40 °F)	Inorganic and organic acids (including HF and nitric), aldehydes, ethylene, glycols, organic oils, silicone oils, vinegar, sour HCs	Black liquor, hot water/steam, hot aliphatic amines, ethylene oxide, propylene oxide, molten sodium, molten potassium
Simriz SZ485 (formerly Aegis PF128)	8	+200 °C @ 16 bar +400 °F @ 232 psi)	70 bar @ +20 °C (1000 psi @ +70 °F)	-7 °C (20 °F)	Inorganic and organic acids (including HF and nitric), aldehydes, ethylene, glycols, organic oils, silicone oils, vinegar, sour HCs, steam, amines, ethylene oxide, propylene oxide, NACE applications	Black liquor, Freon 43, Freon 75, Galden, KEL-F liquid, molten sodium, molten potassium
Kalrez® 6375	A	+200 °C @ 16 bar +400 °F @ 232 psi)	70 bar @ +20 °C (1000 psi @ +70 °F)	-40 °C (-40 °F)	Inorganic and organic acids (including hydro fluids and nitric), aldehydes, ethylene, organic oils, glycols, silicone oils, vinegar, sour HCs	Hot water/steam, hot aliphatic amines, ethylene oxide, propylene oxide

① +180 °C (+350 °F) for options with hazardous locations approval.

3.6.5 Functional – Antenna

Antenna Material	316 SS, PEEK, PTFE, PEK
Process Seal Material	PTFE, PEEK with O-rings
Maximum Process Temperature	Up to +176 °C @ 70 bar (+350 °F @ 1000 psi)
Maximum Process Pressure	PEEK with O-rings: -1 to 70 bar @ +20 °C (-14.7 to 1000 psi @ +70 °F) 4mm PTFE lens: -1 to 5 bar @ +20 °C (-14.7 to 70 psi @ +70 °F) 8mm PTFE lens: -1 to 27 bar @ +20 °C (-14.7 to 400 psi @ +70 °F)
Vacuum Service	Hermeticity to <5 × 10 ⁻⁷ cc/sec helium
Minimum Dielectric (application dependent)	1.7 (1.4 with stillwells)

3.6.6 Antenna Pressure / Temperature Ratings

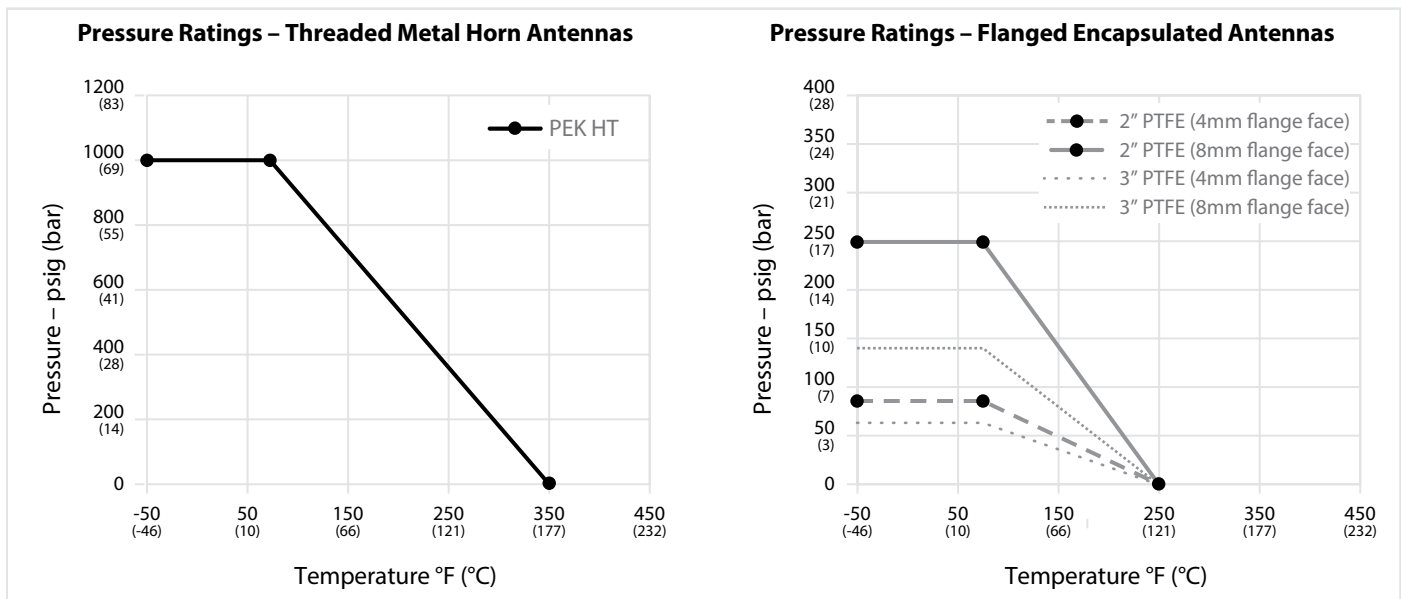

3.6.7 Antenna Pressure / Temperature Ratings

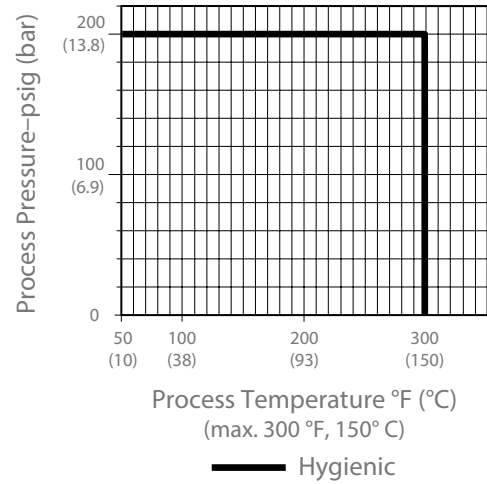
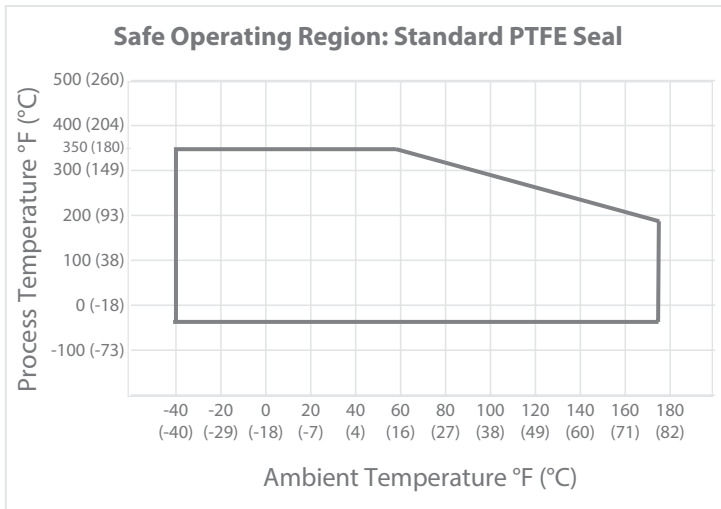

3.6.8 Physical – mm (inches)

Transmitter

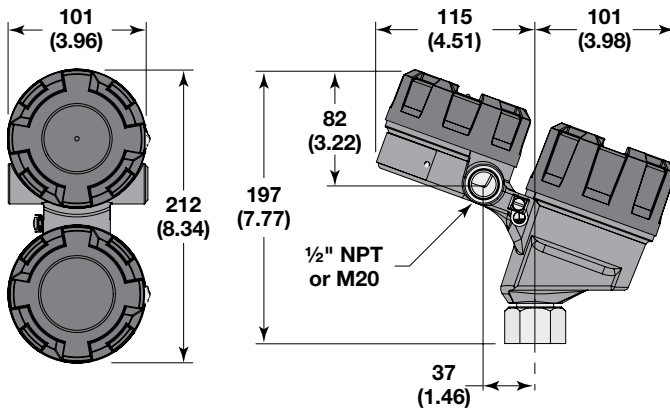

Threaded Metal Antennas

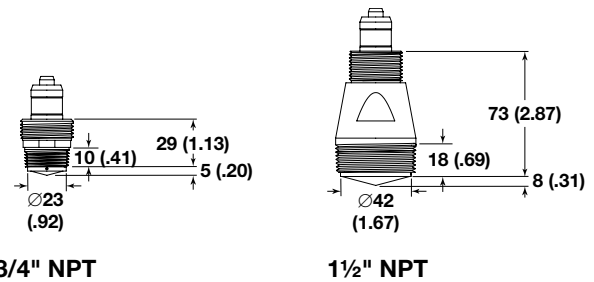

Flanged Encapsulated Antennas

	A	B
4 mm (0.16") Lens	14 (.54)	18 (.69)
8 mm (0.31") Lens	18 (.70)	21 (.83)

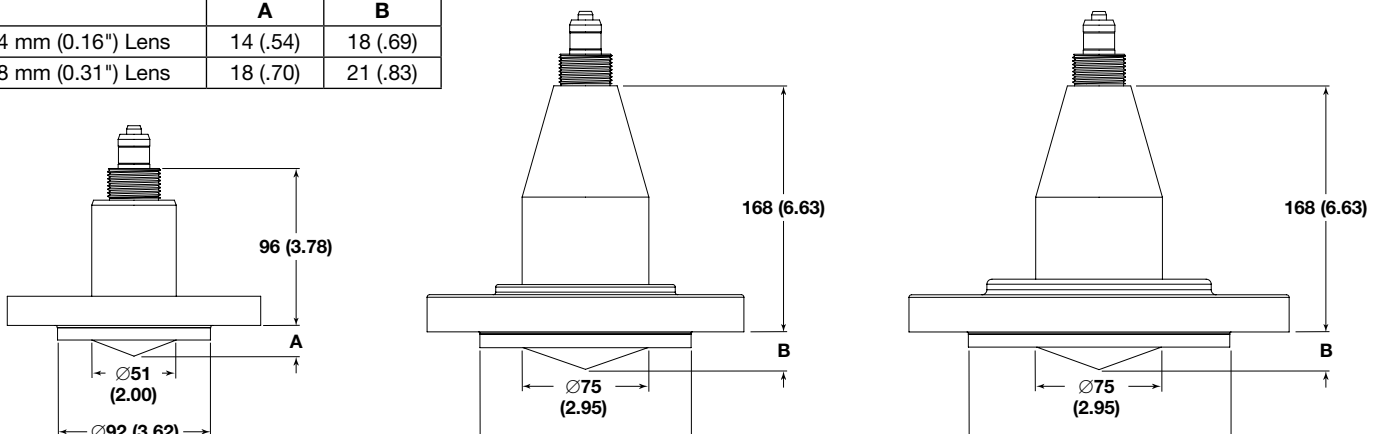

Hygienic Antennas

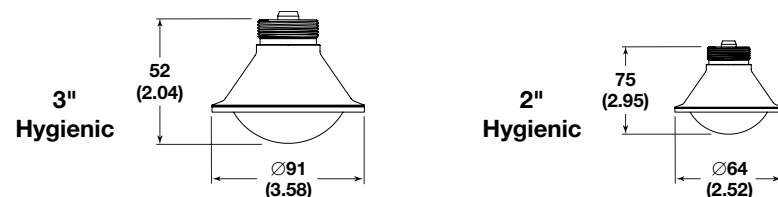

3.7 Replacement Parts

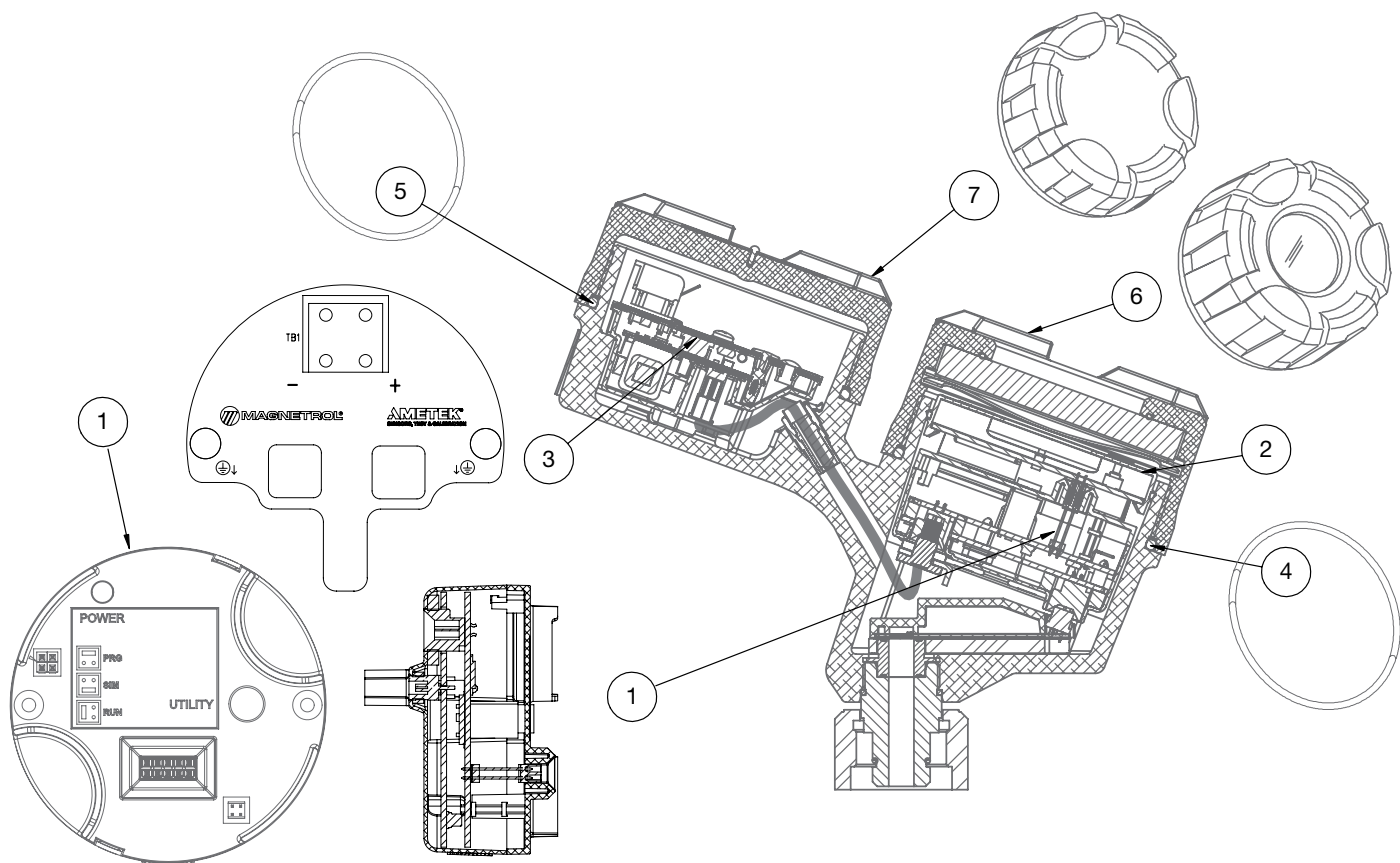

Electronics:

Digit: 1 2 3 4 5 6 7 8 9 10
 Part Number:

→ X = product with a non-standard customer requirement

Serial Number:

See nameplate, always provide complete part number and serial number when ordering spares.

(1) Electronic Module		
Digit 5	Digit 6	Replacement Part
1	1	Z31-2879-001

(4) (5) O-ring	
Replacement Part	
012-2601-237	

(2) Display Module		
Digit 5	Digit 7	Replacement Part
1	0, 3	N/A
	A, D	089-9136-001

(6) Housing Cover			
Digit 7	Digit 8	Digit 9	Replacement Part
0, 3	all	1	004-9225-002
		2	004-9225-003
A, D	all	1	036-4413-013
		2	036-4413-016

(3) Wiring PC Board		
Digit 5	Digit 8	Replacement Part
1	0, 1, D	Z30-9816-001
1	C	Z30-9816-002
1	3	Z31-2865-002

(7) Housing Cover	
Digit 9	Replacement Part
1	004-9225-002
2	004-9225-003

3.8 Model Numbers

3.8.1 Pulsar Model R80 Radar Transmitter

1-3 | MEASUREMENT SYSTEM

R 8 0	Through-Air Radar Level Transmitter - 80 GHz FMCW Radar
--------------	---

4 | POWER

5	24 VDC, Two Wire
----------	------------------

5 | SIGNAL OUTPUT

1	4-20 mA with HART
----------	-------------------

6 | SAFETY OPTIONS

1	SIL 2 Hardware
----------	----------------

7 | ACCESSORIES/MOUNTING

0	No Digital Display and Keypad – Integral with rotatable housing
3	No Digital Display and Keypad – Integral with non-rotatable housing (Available only with 8th digit = 0)
A	Digital Display and Keypad – Integral with rotatable housing
D	Digital Display and Keypad – Integral with non-rotatable housing (Available only with 8th digit = 0)

8 | CLASSIFICATION

0	General Purpose, Weatherproof (IP 67)
1	Intrinsically Safe (Available only with 7th digit = 0 or A)
3	Explosion-proof/Flameproof (with IS antenna) (Available only with 7th digit = 0 or A)
C	Non-Incendive, Increased Safety (Available only with 7th digit = 0 or A)
D	Dust Ignition-proof / Protection by Enclosure (Available only with 7th digit = 0 or A)

9 | HOUSING

1	Die-cast Aluminum, Dual Compartment, 20-degree
2	Investment Cast, 316ss, Dual Compartment, 20-degree

10 | CONDUIT CONNECTION

0	½" NPT
1	M20
2	½" NPT with sunshade
3	M20 with sunshade

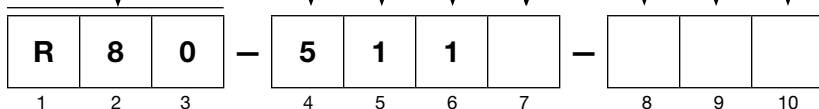

3.8 Model Numbers

3.8.2 Pulsar Model R80 Radar Antenna

1-2 | MEASUREMENT SYSTEM

R C	Through-Air Radar Level Transmitter - 80 GHz FMCW Radar
------------	---

3 | CONFIGURATION/STYLE

0	¾" Horn
1	1½" Horn
2	2" Horn ①
3	3" Horn ①

4-5 | PROCESS CONNECTION - SIZE/TYPE

1 1	¾" NPT	3 1	1½" NPT thread
------------	--------	------------	----------------

ASME Flanges

4 3	2" 150# ASME raised face flange	D A	DN 50, PN 16	EN 1092-1 Type A
4 4	2" 300# ASME raised face flange	D B	DN 50, PN 25/40	EN 1092-1 Type A
4 5	2" 600# ASME raised face flange	D D	DN 50, PN 63	EN 1092-1 Type B2
5 3	3" 150# ASME raised face flange	D W	DN 50, PN 16	EN 1092-1 Type B1
5 4	3" 300# ASME raised face flange	D Z	DN 50, PN 25/40	EN 1092-1 Type B1
5 5	3" 600# ASME raised face flange	E A	DN 80, PN 16	EN 1092-1 Type B1
6 3	4" 150# ASME raised face flange	E B	DN 80, PN 25/40	EN 1092-1 Type A
6 4	4" 300# ASME raised face flange	E D	DN 80, PN 63	EN 1092-1 Type B2
6 5	4" 600# ASME raised face flange	E W	DN 80, PN 16	EN 1092-1 Type B1

EN (DIN) Flanges

E Z	DN 80, PN 25/40	EN 1092-1 Type B1
F A	DN 100, PN16	EN 1092-1 Type A
F B	DN 100, PN 25/40	EN 1092-1 Type A
F D	DN 100, PN 63	EN 1092-1 Type B2
F W	DN 100, PN 16	EN 1092-1 Type B1
F Z	DN 100, PN 25/40	EN 1092-1 Type B1

Hygienic (Available only with 8th digit = A)

4 P	2" Tri-Clover® type, 16 AMP hygienic flange	F B	DN 100, PN 25/40	EN 1092-1 Type A
5 P	3" Tri-Clover® type, 16 AMP hygienic flange	F D	DN 100, PN 63	EN 1092-1 Type B2

6 | CONSTRUCTION CODES

0	Industrial
K	ASME B31.1
L	ASME B31.3
M	ASME B31.3 & NACE MR0175 / MR0103
N	NACE MR0175 / MR0103

8 | MATERIAL OF CONSTRUCTION - WETTED SURFACES

A	316SS/316L SS (Available with threaded process connection:4th digit = 1 or 3, or Hygienic: when 5th digit = P)
1	PTFE Faced Flange: 4mm (0.16") thick ②
2	PTFE Faced Flange: 8mm (0.31") thick ②

10 | O-RING MATERIALS/SEAL OPTIONS

0	Viton VX065
2	Kalrez 4079
8	Simriz SZ485 (formerly Aegis PF128) — NACE
A	Kalrez 6375
N	None (When 3rd digit = 2 or 3)

- ① 2" or 3" horn required for FCC/ETSI/ISED (Out of Tank)
- ② Must be used with 10th digit = N.

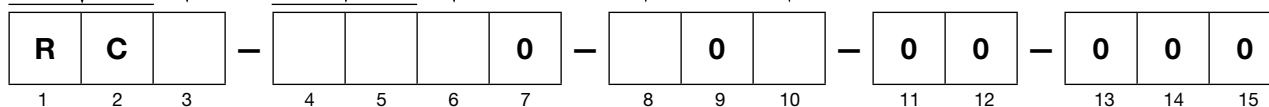

4.0 Advanced Configuration/Troubleshooting Techniques

This section contains information regarding some of the advanced configuration and troubleshooting capability contained within the Model R80 transmitter. Some of these diagnostic options are best suited for use with PACTware and the Model R80 DTM, and should be implemented only after contacting Magnetrol Technical Support.

4.1 Echo Rejection

After choosing a proper mounting location, another way to ignore unwanted signals within the measuring range is by utilizing the Echo Rejection feature.

Setup using DTM/PACTware™

Select the Diagnostics tab and then the Echo Curve tab. After refreshing the waveform, click on the New Rejection Curve button.

The screenshot shows the 'PULSAR # Online parameterization' software interface. At the top, there's a header with device details: Model: Model R86 Pulsar ® Pulse Burst Radar Level Transmitter, Tag: PULSAR, Level: 10.76 ft, Echo Strength: 19, Description: Thru-Air Radar Level Xmtr, Long Tag: Pulsar Model R86, Magnetrol S/N: 77439012001, Descriptor: Pulsar Model R86, PV % Range: 54.8 %, Echo Margin: 11, and a warning icon for 'Reject Curve Invalid'. Below the header is a navigation bar with tabs: Home, Device Setup, Diagnostics. The 'Diagnostics' tab is active, and within it, the 'Echo Curve' sub-tab is selected. The main area features a graph of Echo Strength (0 to 40) versus Level [ft] (15.00 to 0.00). Below the graph is a configuration panel with various settings: Curve 1: Live, Curve 2: None, Dielectric Range: Above 10, Foam: None, Turbulence: None, Target Selection: First Echo, Target Thresh Mode: Automatic, Target Thresh Value: 25 %, Base Threshold: 8, Echo Rejection Type: Standard, Echo Reject State: Disabled, Echo List Mode: Distance, Saved Reject Distance: 19.20 ft. A 'New Rejection Curve' button is located at the bottom right of the configuration panel, with an arrow pointing to it from the text 'Press to Initiate Function' below the screenshot.

Press to Initiate Function

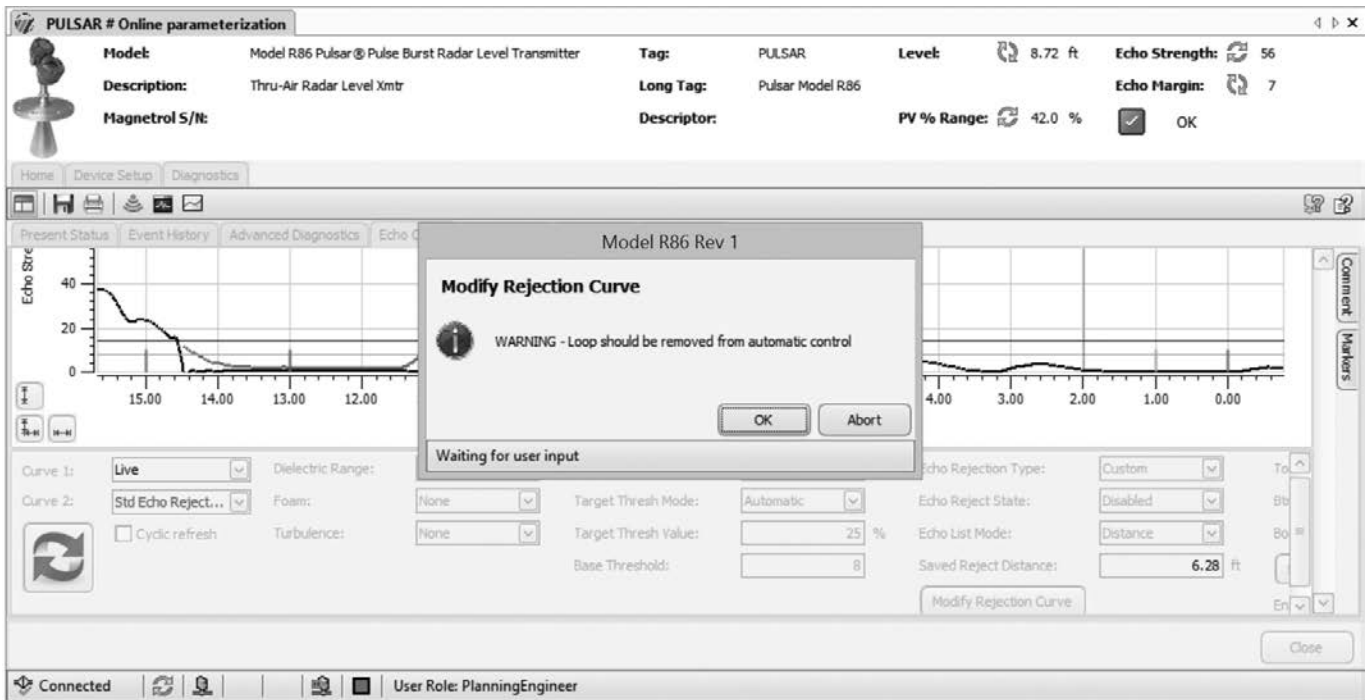

Click on NEXT at the loop warning message.

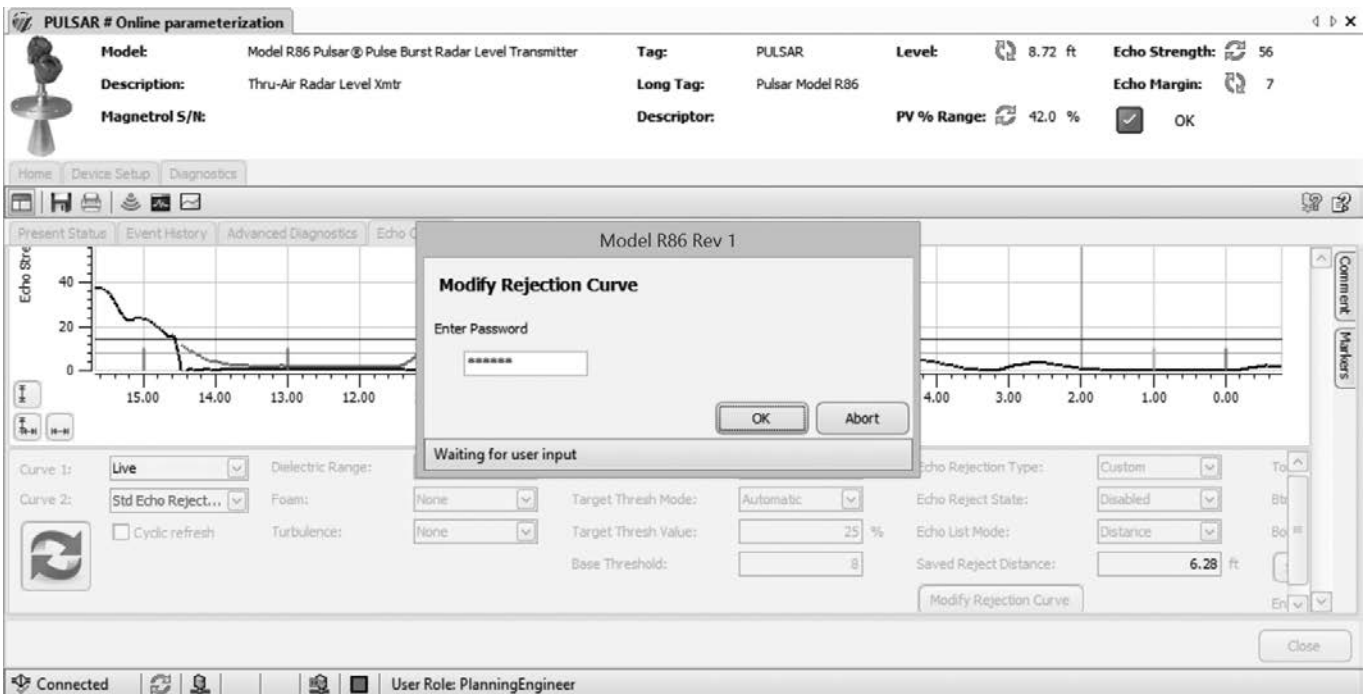

A password window will then appear. Click OK. The system calculates the curve, and then saves it. Click OK to confirm.

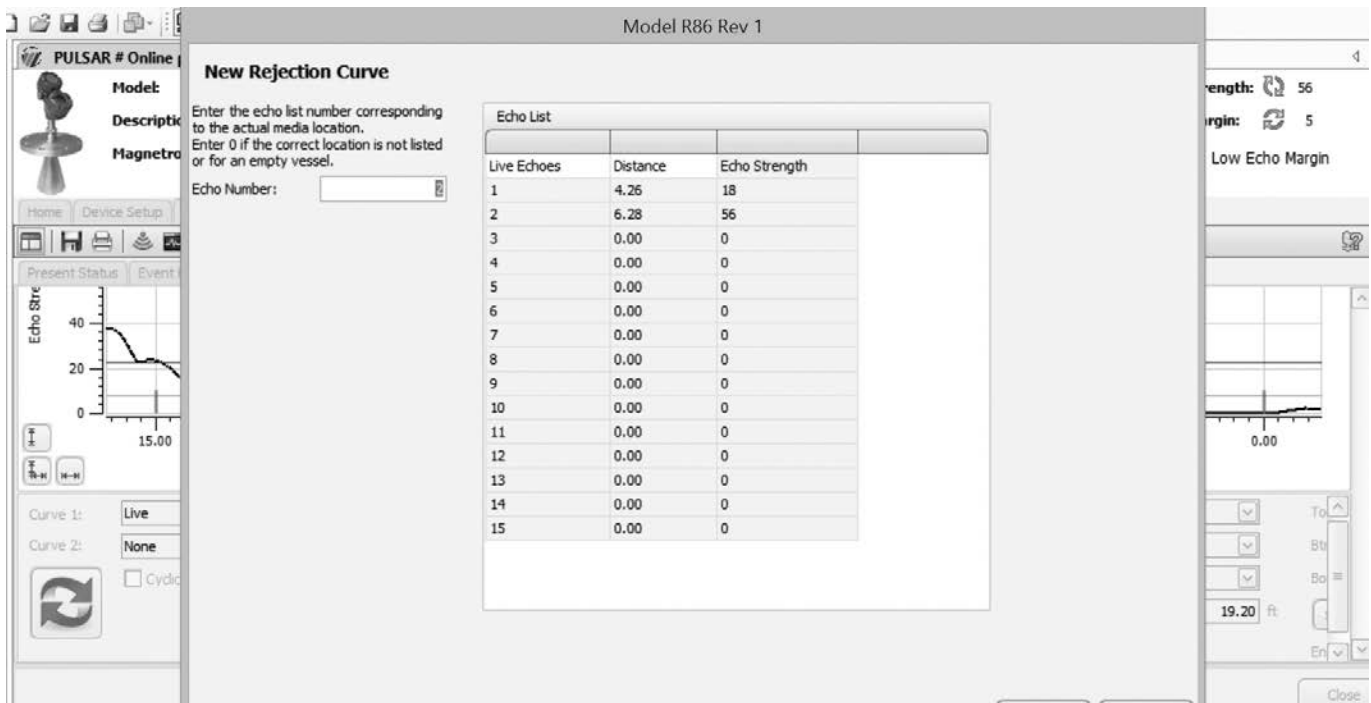

On the next screen, enter the actual location of the level to be measured. Press ENTER and then click on NEXT.

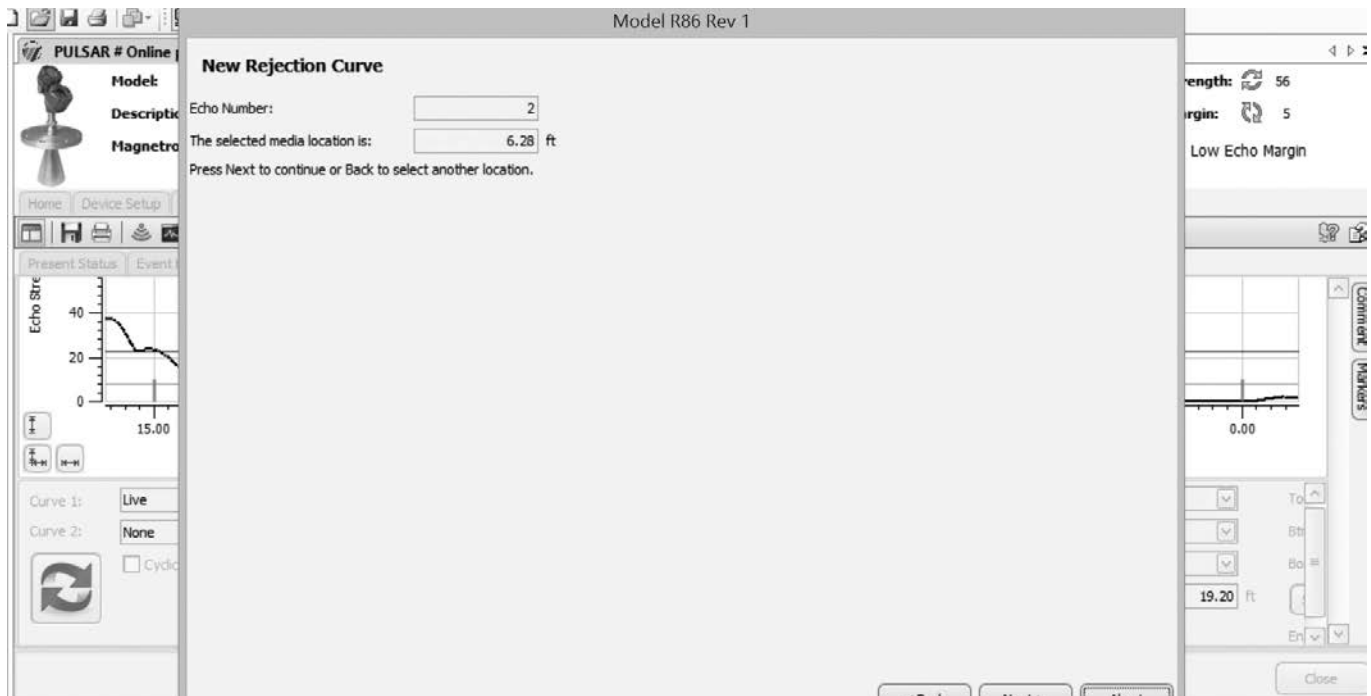

Press NEXT to confirm.

The Live Curve and Rejection Curve will then be displayed as shown in the screenshot below.

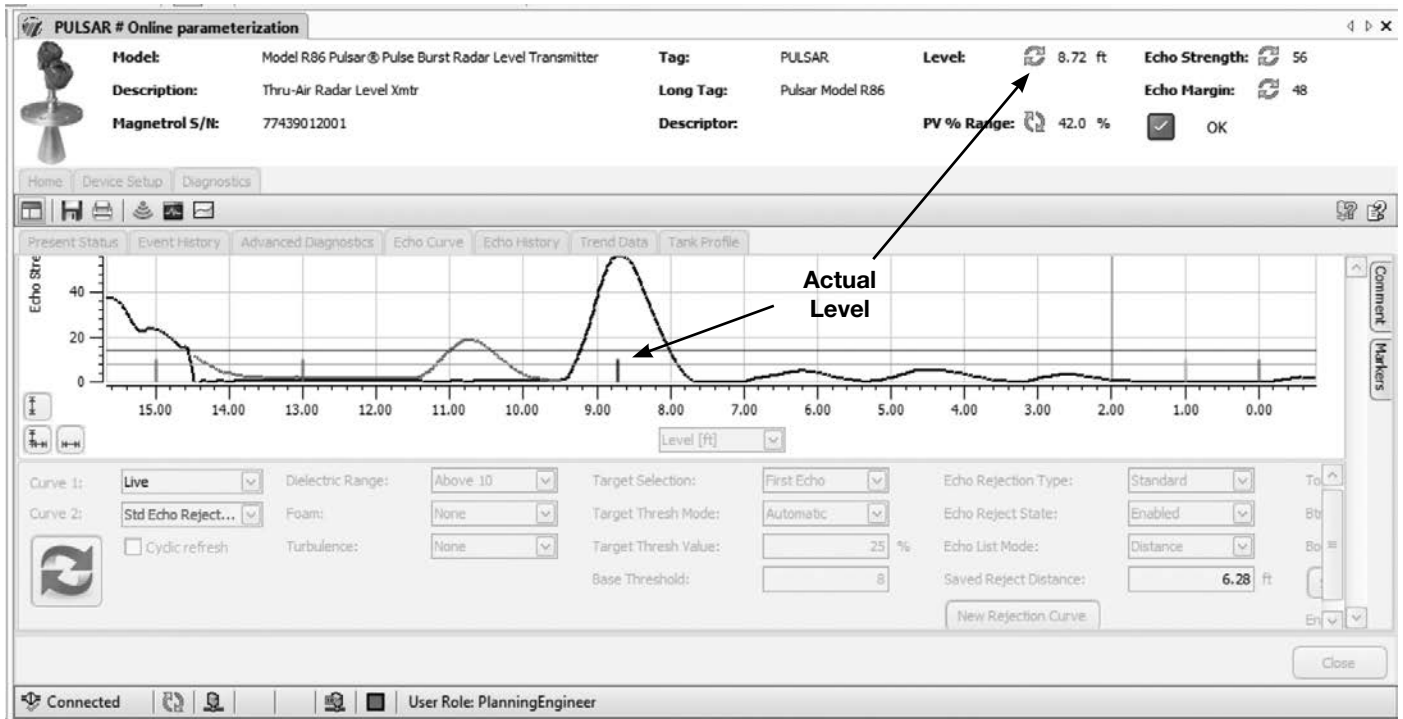

A warning screen is shown that the loop can be returned to automatic control.

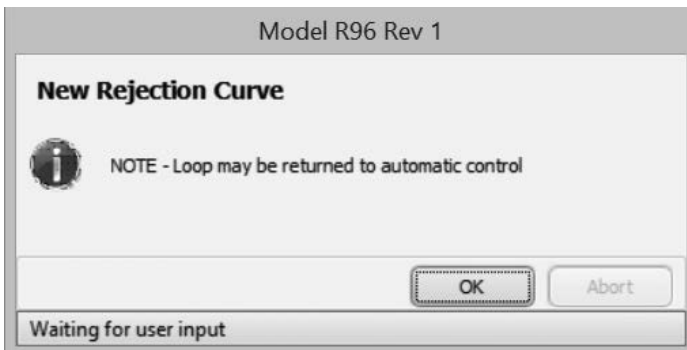

4.2 Custom Echo Rejection

INTRODUCTION

The Pulsar Model R80 has a very unique feature that allows for a user to modify a Standard Echo Rejection curve.

Custom Echo Rejection is a feature intended to allow a user to manually adjust the curve to account for undesirable waveform features (noise, disturbances, etc.) that may not have been captured by the initial Standard Echo Rejection curve.

For example, undesirable signals may occur if the original echo rejection curve was taken at a time when mixing blades were stopped in a particular location. If the blades then later stop in a different location, a false echo from the blade could then appear in the live echo curve. Custom Echo Rejection can then be used to modify the Standard Echo Rejection curve in order to ensure that all “false echoes” are cancelled out of the waveform.

The Custom Echo Rejection curve is offered in addition to the Standard Echo Rejection curve. Once a Custom Echo Rejection curve has been created, either curve is available for use by the user to reject unwanted echo echoes. The user has the ability to select which curve (or no curve) will be used for echo rejection.

Since the local display does not have the ability to concurrently display the live and rejection echo curves, the manipulation of the echo rejection curve will be done in the DD and DTM only. The ability to view the two curves graphed together is essential in determining how the rejection curve should be modified to provide the desired outcome.

When the Custom Echo Rejection curve is selected for use, the “New Rejection Curve” button will change to “Modify Rejection Curve”. Clicking on this button will guide a user through:

- modifying an existing echo in the custom curve
- copying an echo from the live curve to the custom rejection curve
- resetting a Custom Echo Rejection curve back to the original form from which it was taken (Standard Echo Rejection curve).

OPERATION

BEFORE STARTING: Note that changes to certain parameters cause the Echo Rejection profile to become invalid. Those parameter changes will invalidate both the Standard and the Custom rejection curves simultaneously, regardless of which echo rejection curve option is selected at the time. For example, making any changes to Gain parameters (Dielectric, Turbulence, Foam and Sensitivity) or Tank Height parameter will invalidate all Echo Rejection Curves whether Standard or Custom.

The Custom Echo Rejection curve can be modified in three ways:

1. Modify existing Echo

Changing the amplitude or width of an existing echo in the Custom Rejection Curve is the most typical use of this method. For example, it can be used to account for the variations in mixing blade operation. If mixing blades are stopped when the initial curve was created, the next time the blades stop they may be in a slightly different position. The new blade position can result in a slightly different position of its echo. Echoes from the blade will appear in the echo curve as slightly shifted to the left or right compared to the echo in the original curve. The amplitude may also be somewhat different. In that case, expanding the width of the existing echo, or changing its amplitude would create an echo rejection curve that encompasses both the original echo and the new echo locations.

2. Add an Echo

This is used to copy an echo from the live curve to the Custom Rejection Curve. This would be done in the event that a new echo was found in the live curve after the initial echo rejection curve had been saved.

NOTE: In the case where the level at the time was higher in the tank, saving a new entire echo rejection curve would result in a lower portion of the rejection curve being lost. Therefore, it is beneficial in that circumstance to be able to add the echo to the existing custom curve so that the lower portion of the curve is retained.

3. Reset Custom Curve

If the need arises to eliminate changes made during any of the previous modification procedures, Reset Custom Curve is used to reset the Custom Rejection Curve back to its original values.

PROCEDURES

Changing the widths and amplitude of an existing echo:

Modifying an existing echo in the custom rejection echo curve consists of the user identifying the desired echo and defining the changes to be made to that echo. The user begins the Customize Rejection Curve method in the DTM at Diagnostics/Echo Curve.

1. Ensure a Standard Echo Rejection has been captured before continuing (Standard Echo Rejection will appear as red curve on graph).

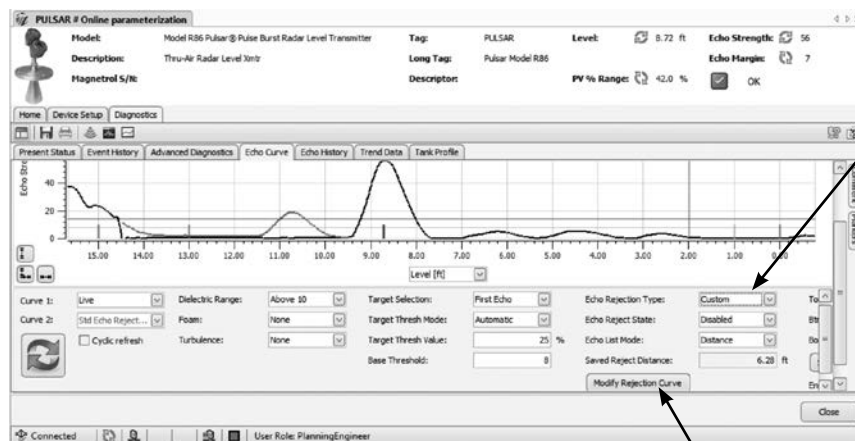

Change "Echo Rejection Type" from "Standard" to "Custom"

The "New Rejection Curve" button changes to "Modify Rejection Curve"; press button

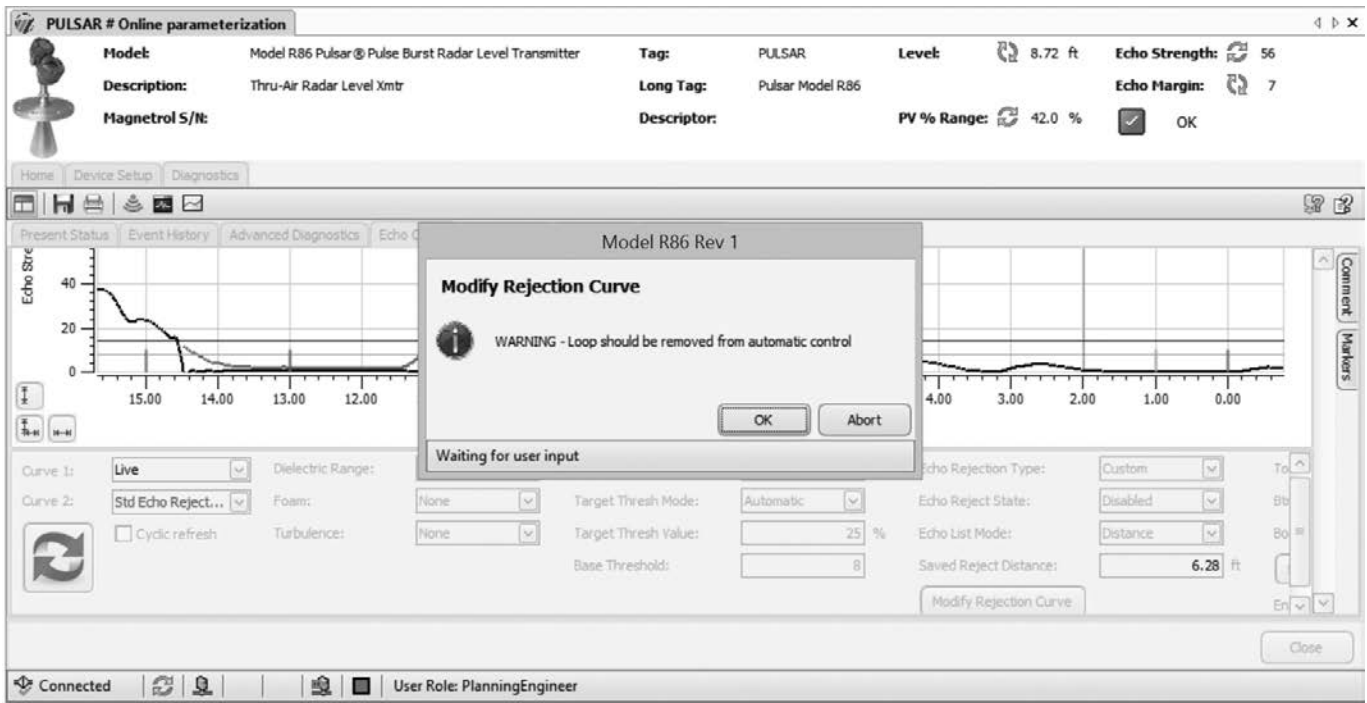

Click on NEXT at the loop warning message.

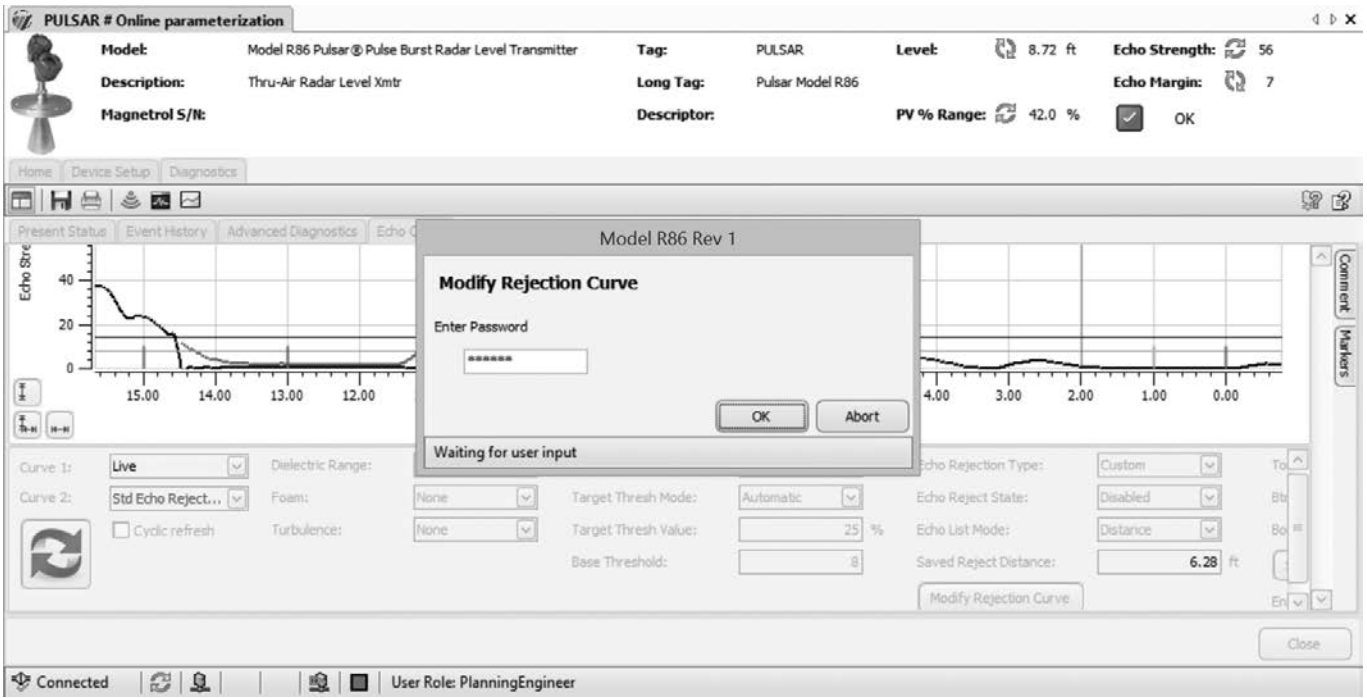

A password window will then appear. Click OK.

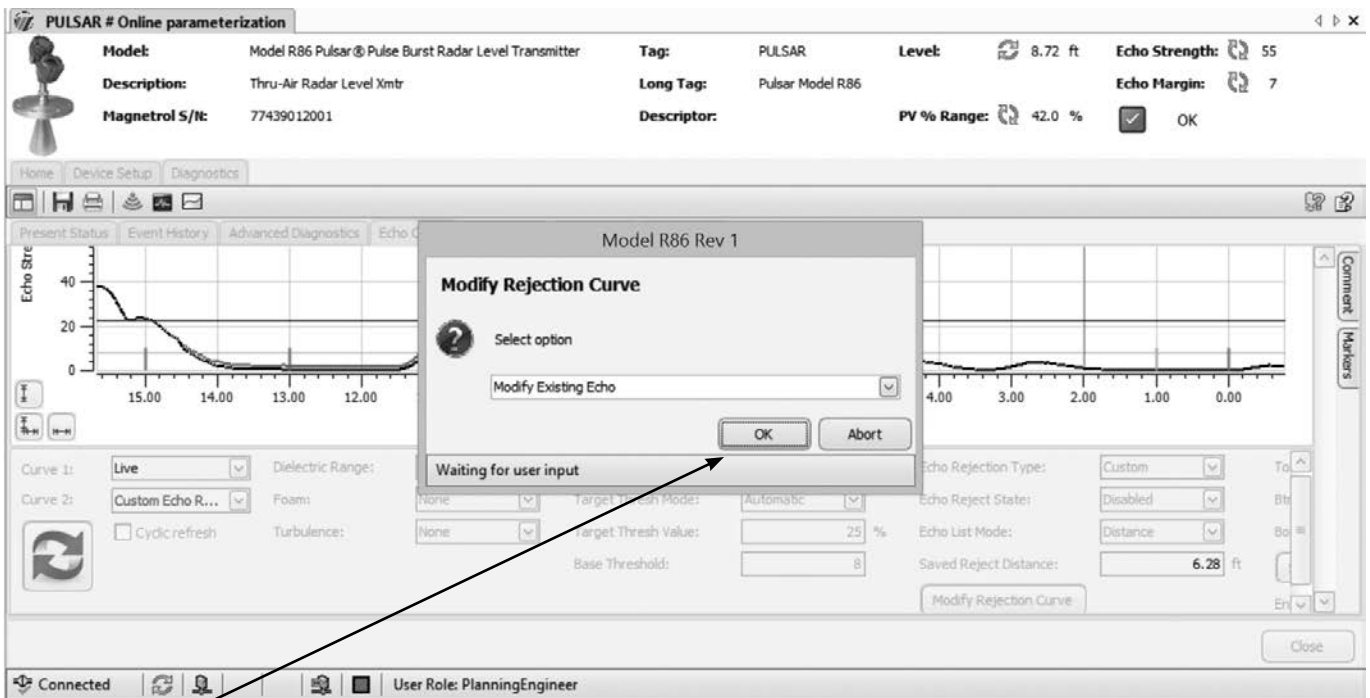

Click OK.

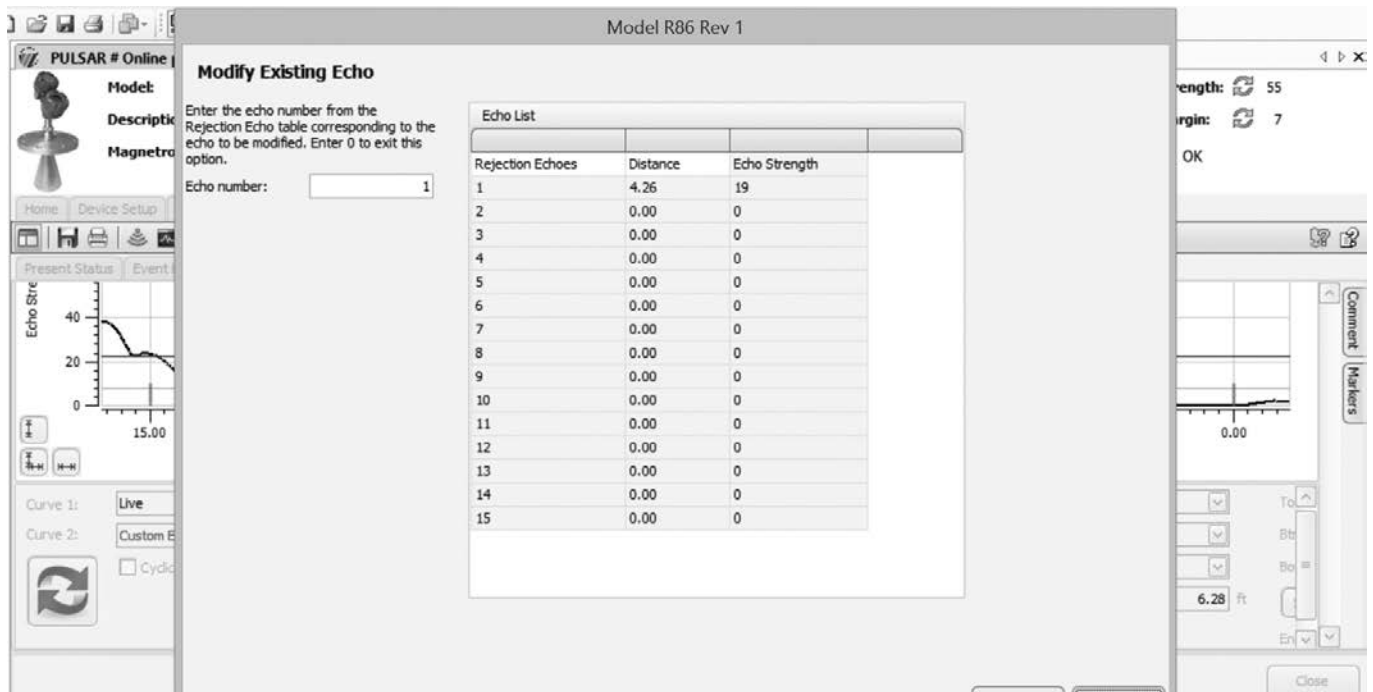

Upon presentation of the Rejection echo list (including the echo amplitudes), along with a display of the present level, select the desired false echo to be modified. (The distance to the echo must be smaller than the distance to the level echo).

Modify Existing Echo

Echo Number:

Echo 1 Location: ft



	Left Location	Strength	Right Location
	ft		ft
Original	3.78	19	4.66
Requested	3.78	19	4.66

Modify Existing Echo

Echo Number:

Echo 1 Location: ft



	Left Location	Strength	Right Location
	ft		ft
Original	3.78	19	4.66
Requested	3.50	19	4.66

Revise left location and press ENTER. (Right location and/or strength can also be revised.)

Modify Existing Echo

Echo Number:

Echo 1 Location: ft



	Left Location	Strength	Right Location
	ft		ft
Original	3.46	19	4.66
Requested	3.46	22	4.80

PULSAR # Online parameterization

Model: Model R86 Pulsar @ Pulse Burst Radar Level Transmitter Tag: PULSAR Level: 8.72 ft Echo Strength: 56

Description: Thru-Air Radar Level Xmr Long Tag: Pulsar Model R86 Echo Margin: 7

Magnetrol S/It Descriptor: PV % Range: 42.0 % OK

Home | Device Setup | Diagnostics

Present Status | Event History | Advanced Diagnostics | Echo Curve | Echo History | Trend Data | Tank Profile

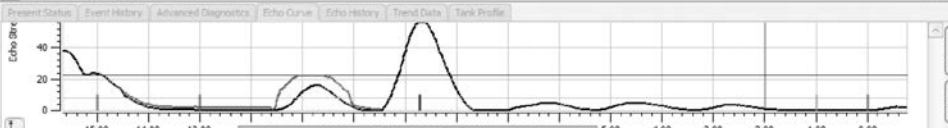

Modify Existing Echo

2 Select option

Apply Custom Curve

OK Abort

Waiting for user input

Click OK.

PULSAR # Online parameterization

Model: Model R86 Pulsar @ Pulse Burst Radar Level Transmitter Tag: PULSAR Level: 8.72 ft Echo Strength: 56

Description: Thru-Air Radar Level Xmr Long Tag: Pulsar Model R86 Echo Margin: 48

Magnetrol S/It Descriptor: PV % Range: 42.0 % OK

Home | Device Setup | Diagnostics

Present Status | Event History | Advanced Diagnostics | Echo Curve | Echo History | Trend Data | Tank Profile

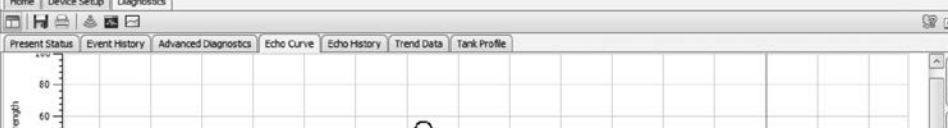

New Rejected Area

Curve 1: Live Dielectric Range: Above 10 Target Selection: First Echo Echo Rejection Type: Custom To: ^

Curve 2: Custom Echo R... Foams: None Target Thresh Mode: Automatic Echo Reject State: Enabled Bt: v

4.3 Tank Profile

Introduction

Non-Contact radar transmitters are typically configured and commissioned with a static liquid level. Ideally, the installer will generate some level change after commissioning to verify proper operation, but rarely can one witness a complete fill and empty cycle of the vessel. Therefore, the transmitter configuration may not initially be optimized for the entire range of operation.

Although previous versions of Magnetrol transmitters contain troubleshooting options for recording and saving diagnostic information such as Data Log, Event History, and Echo History, none contains a way for the device to automatically capture pertinent information for an entire fill and empty cycle. As this complete cycle could take hours, days or even weeks to complete, having this information will confirm proper operation for a given configuration or can provide precious information about the transmitter performance at troublesome levels in the tank.

The information is stored in the transmitter, retrieved at a later time and evaluated by a qualified individual who will decide the next steps to take.

A few items to note:

1. The Tank Profile feature must be manually initiated. It is not an automatic feature.
2. The Tank Profile feature may be manually stopped at any time.
3. Before the feature starts capturing information, the transmitter configuration should be manually saved. This is not necessary for the operation of the feature but provides useful data for determining what configuration change may be warranted.
4. Although the ability to set up and run this feature will be available in all user interfaces (HART and FF LUI, DD and DTM), the results can only be graphically viewed in the corresponding DTM. For DD-based hosts, there is a DD method that will sequentially display the readings one level at a time.
5. The feature can be set to cover a smaller range than the entire tank. For example, some processes may only operate in a smaller range.
6. The increments can be set as a percentage of the Start/Stop range (Increment by %) or in Level/Distance units (Increment by Unit).
7. The information captured at each increment will be:
 - a. Time
 - b. Level
 - c. Distance
 - d. Echo Strength
 - e. Echo Margin
 - f. Loop Current (HART only)
 - g. Target Threshold
 - h. Level Ticks
 - i. BCSM state
8. The saved minimum and maximum Echo Strength and Echo Margin readings can be viewed in a graph in the Tank Profile menu.

SETUP

The Tank Profile can be initiated in the DTM in the following manner:

1. Use SET CLOCK button to ensure transmitter clock is set properly
2. Choose LIMIT UNITS of “Level” or “ % Range”
3. Choose INTERVAL, LIMITS and TIMES applicable to your needs.
4. TANK PROFILE STATUS will display “Off”, “Running” or “Completed”
5. Once computer is used to configure transmitter it does not have to stay connected.
6. Connect computer at later date to download captured data for analysis.

From the DTM, Tank Profile is accessed from the Diagnostics/Tank Profile tabs

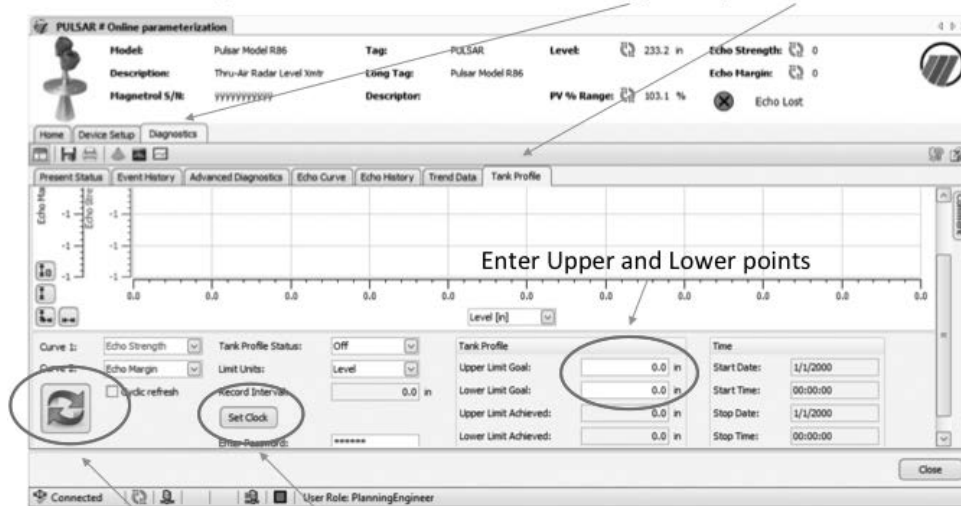

Hit Refresh to begin

Set clock, if desired

Limit Units = PV % Range.....Record Interval and Tank Profile units switch to “%”

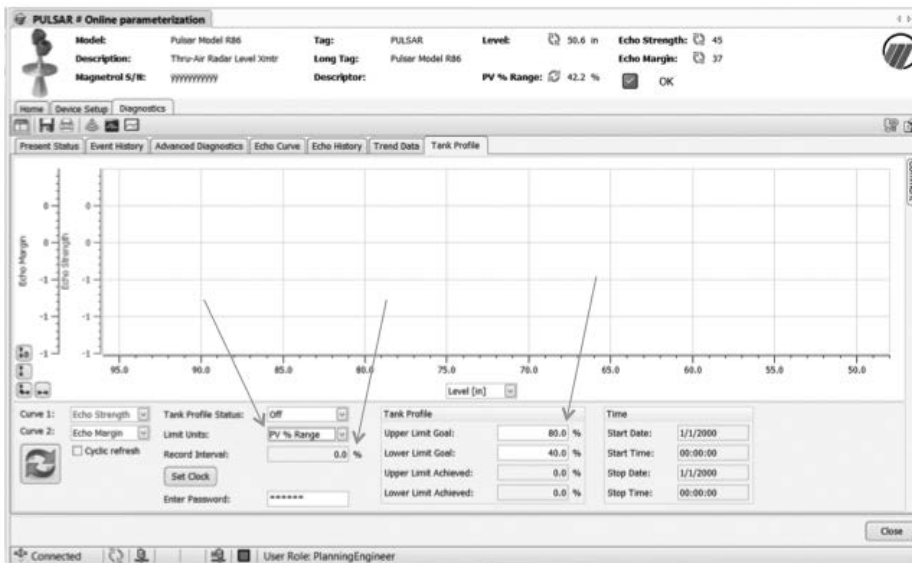

Press "Save" icon upon completion of cycle to save all pertinent data

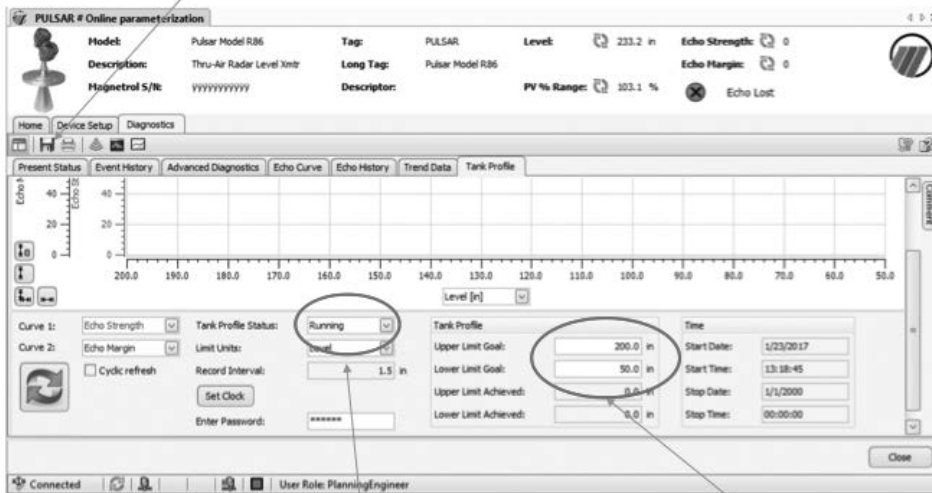

Status shown as "Running"

Designated limits shown

Progress can be conveniently viewed using the DTM

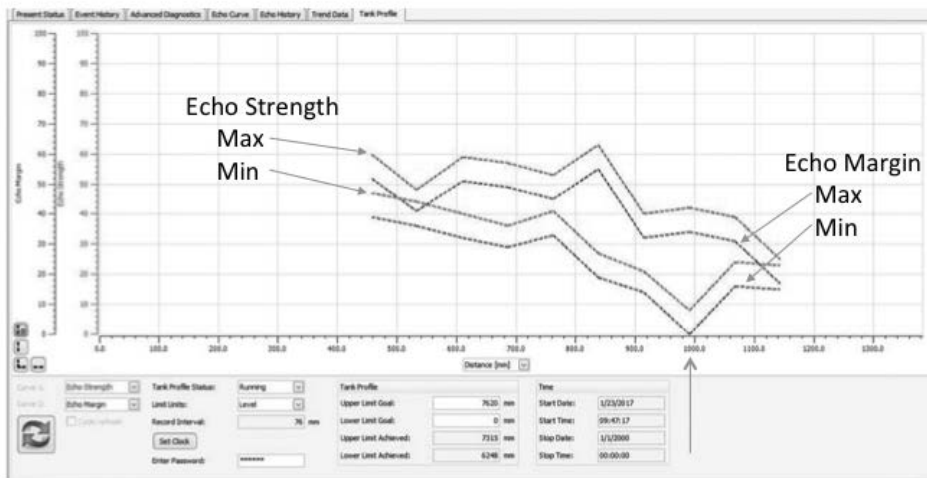

4.4 Echo Margin

Echo Margin is a unique parameter that, when used along with Echo Strength can be a very useful troubleshooting tool. Echo Strength is taken from the standard Signal-to-Noise calculation and is simply defined as:

"The amplitude of the Level echo in Echo Strength units (0-100)"

Echo Margin is defined as:

"A numeric value that is related to the strength of the target peak relative to the Level Threshold or competing waveform features, i.e., noise."

The Echo Margin value (for the typical First Echo mode) is calculated as the difference of the False target-to-Threshold OR the Level target-to-Threshold whichever is SMALLER.

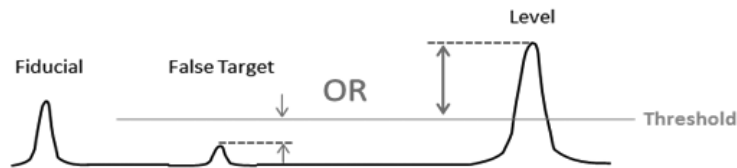

By reporting the SMALLER value, Echo Margin does a better job of reporting which issue is most likely to become a problem:

- False Target- if this echo becomes large enough to rise above the Threshold it will be mistakenly reported as the Level.
- Level Echo- if this echo becomes small enough to fall below the Threshold the transmitter will report Loss of Echo.

Always examine both Echo Strength and Echo Margin values. Increasing a Gain parameter (Dielectric, Turbulence, Foam or Sensitivity) will increase the amplitude of all echoes in the radar scene. If, after increasing a Gain parameter, the Echo Strength increases but the Echo Margin decreases a False Target is reaching closer to the Threshold (see drawing above). If the False Target reaches above the Threshold it will be detected as a valid Level echo and will be incorrectly reported as Level. In this case running Echo Rejection will eliminate the False Target and increase the Echo Margin value. Echo Margin values >20 are a good goal.

4.5 Automated Echo Capture

Unattended Echo Capture

One of the ways the Model R80 simplifies an often complex technology like Radar, is to improve the speed at which a user can turn around a problem and get the device back online. Minimizing down time is the ultimate goal of any device.

One of the most important tools used to troubleshoot a Radar application or optimize a transmitter configuration is the echo curve. This graphical representation of a Radar echo speaks volumes to those trained to interpret them. It is like a snapshot in time of the health of the transmitter. It is actually like seeing inside of the tank. However, the challenge with echo curves is acquiring them in a timely fashion. Unfortunately, most problems develop when there is a skeleton crew and no one watching this particular vessel. By the time an instrument technician can investigate, the alarm has cleared and no one understands why it occurred or, more importantly, when it will happen again. Since an echo curve is so important in troubleshooting the device, it is critical to capture the curve at the instant a problem occurs. Too often this means connecting a laptop and gathering information AFTER the first signs of the problem, which is obviously not ideal.

The advanced Pulsar Model R80 design is very effective at addressing this issue. This advanced design allows the transmitter to automatically capture an Echo Curve based on an Event (such as Loss of Echo) or Time (using the on-board clock).

It is shipped from the factory so an echo curve is automatically captured based on key Events. The transmitter has the ability to store a number of echo curves in its on-board memory. These echo curves can then be downloaded to a laptop running software such as PACTware and reviewed in Diagnostics/Echo History tab. If necessary, the user can email this information to the factory for expert assistance in troubleshooting. This enables the problem to be resolved much more quickly, minimizing possible down time.

A number of points should be made in this example:

- Curve 1 is showing the current Live echo
- Curve 2 is showing “History 9” – the 9th echo stored in memory which was automatically captured at 5:40 p.m. on 4/5/2017
 - This echo capture was triggered by the “Low Echo Margin” diagnostic

SETUP

NOTE: The transmitter is shipped from the factory configured to automatically capture Echo Curves based on “Events” with ALL Events being enabled.

Automated Echo Capture is configured in the DTM in the following manner:

Open DTM to Diagnostics/Echo History

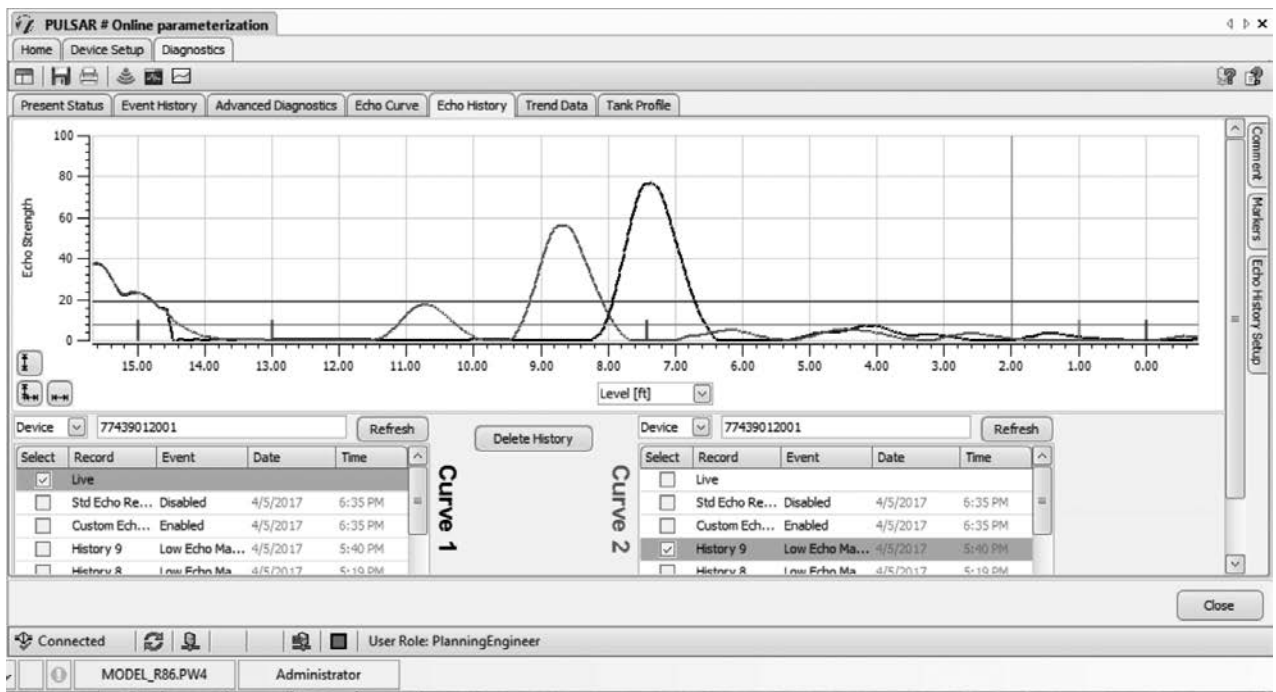

4.6 Event History

Although Event History has been included (and found to be very useful) in other Magnetol devices, it has been improved in the Model R80.

Event History becomes the main repository of all key Diagnostic and Configuration data. It now displays a history of the 20 most recent diagnostic indicators and configuration changes. For each event, the time when the event occurred and the duration of the event are shown. The table of history indicators displays the most recent indicator at the top with preceding indicators in descending order.

NOTE: A “+” suffix denotes the event remains active

Key Features:

- 20 lines of Event information
- All Diagnostic and Configuration info
- Now 7 columns of data
- Item #
- Event name
- Date
- Time
- Duration
- Value1
- Value2

Value1 and Value2 entries have various meanings depending on the Event. (A comprehensive explanation of these entries is included in this section.) It is highly recommended to Set Clock (in transmitter) if actual Dates and Times are not shown.

(Although Event History can be viewed via the Local User Interface, the DTM offers a more complete view of the information.)

Press “Refresh Event History” upon opening the screen.

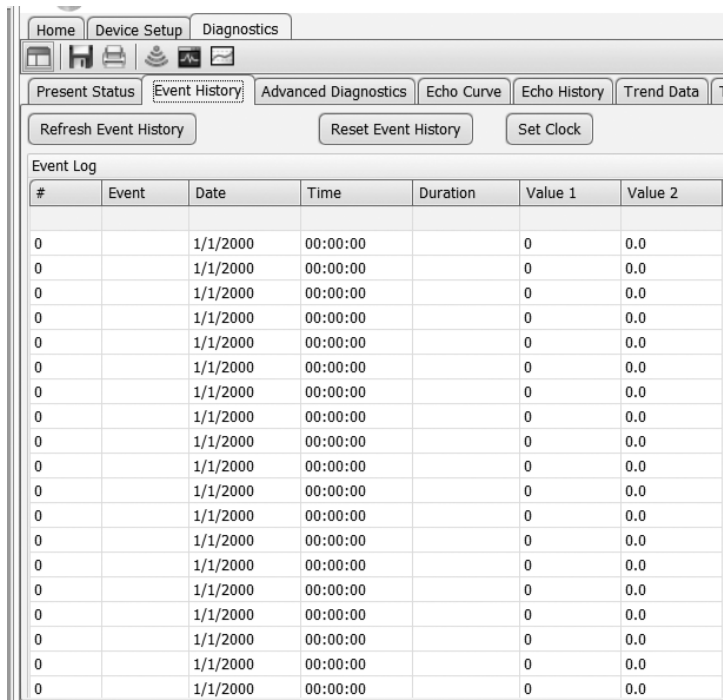

+ indicates event is active

#	Event	Date	Time	Duration	Value1	Value2
20	BC Level	2017-01-18	13:05:21	022:34:12+	12	18.0
19	Echo Reject State	2017-01-15	11:14:01	000:00:00	0	2.0
18	Std. Echo Rejection	2017-01-15	11:10:59	000:00:00	0	24.1
17	Foam	2017-01-15	11:08:39	000:00:00	1	35.0
16	Echo Curve	2017-01-15	09:41:45	000:00:00	2	83.2
15	Echo Lost	2017-01-15	09:41:15	000:87:45	0	83.2
14	Foam	2017-01-15	09:40:13	000:00:00	0	9.0
13	Max. Jump Exceeded	2017-01-12	01:26:41	000:00:49	32	118.5
12	Echo Reject State	2017-01-12	01:25:23	070:02:13	20	27.4
11	Foam	2017-01-12	01:25:23	000:00:00	2	88.0
10	BC Level	2017-01-08	15:51:20	000:17:49	1	33.1
9	Echo Reject State	2017-01-08	15:51:05	000:00:00	0	2.0
8	Echo Curve	2017-01-08	15:32:46	000:00:00	7	29.5
7	Low Echo Margin	2017-01-08	15:32:16	000:00:00	5	29.5
6	BC Level	2017-01-08	15:31:10	028:35:45	01	42.1

7 LOW ECHO MARGIN

Value 1 - EM value when captured
Value 2 - Level value when captured

Event History – Value1/Value2 Look-up Table

Event	Value1	Value2
ALL DIAGNOSTIC INDICATORS (unless otherwise noted below)	0 = No value (unused)	Level value when captured
Analog Board Error	Error Code	0 = No value (unused)
Analog Output Error	Measured current	Expected current
Boundary Condition State (BCS) changes, Echo Lost and Inferred Level	XX- 2-digit value 1st digit = Beginning state 2nd digit = Ending state Based on following codes: 0 = Initialization 1 = Level (normal) 2 = Empty 3 = Full 4 = Echo Missing 5 = Echo Lost 6 = No Fiducial 7 = Restart	Level value when captured
Echo Curve (automated capture)	Capture based on: 12 - Too Many Echoes 14 - Echo Lost 17 - High Volume Alarm 18 - High Flow Alarm 28 - Inferred Level 33 - Max Jump Exceeded 34 - Low Echo Margin	Level value when captured
Echo Lost	See BCS changes	
High Electrical Temp	0 = No value (unused)	Temp when activated
High Surface Velocity	Value when activated	Level value when captured
Inferred Level	See BCS changes	
Low Echo Margin	Value when activated	Level value when captured
Low Electrical Temp	0 = No value (unused)	Temp when activated
Low Supply Voltage	Extrapolated terminal Lower voltage	Extrapolated terminal Upper voltage
Max. Jump Exceeded	Beginning Level value	Ending Level value
Reject Curve Invalid	0 = No value (unused)	0 = No value (unused)
Reset Max/Min Temperatures	Max Temp before reset	Min Temp before reset
Sweep Time Error	DAC setting	Sweep width
Too Many Echoes	Number of Echoes found	Level value when captured

Configuration Parameters

Event	Value1	Value2
# Run Average	Old value	New Value
4mA (LRV)	Old value	New value
20mA (URV)	Old value	New value
Base Threshold	Old value	New value
Bottom Blocking Distance	Old value	New value
Custom Echo Rejection	0 = No value (unused)	Level value when captured
Dielectric	0 = 1.4–1.7 1 = 1.7–3.0 2 = 3.0–10 3 = >10	Corresponding Echo Strength

Configuration Parameters (continued)

Event	Value1	Value2
Echo Rejection Type 2 = Standard Echo Rejection 3 = Custom Echo Rejection	Old value	New Value
Echo Reject State	Old Value 0 = Off 1 = Disabled 2 = Enabled	New Value
FME Distance Threshold	Old value	New Value
Foam	0 = None 1 = Light 2 = Medium 3 = Heavy	Corresponding Echo Strength
HART Poll address	Old value	New value
Level Trim	Old value	New value
Max Level Jump	Old value	New value
Max Surface Velocity	Old value	New value
Passwords (Date/Time only)	0 = No value (unused)	0 = No value (unused)
Rate of Change	Old value 0 = <5 in/min (<130mm/min) 1 = 5–20 in/min (130–500mm/min) 2 = 20–60 in/min (500–1500mm/min) 3 = >60 in/min (>1500mm/min)	New value
Sensitivity	Value	Corresponding Echo Strength
Standard Echo Rejection	0 = No value (unused)	Level value when captured
Stillwell ID	Old value	New value
Tank Height	Old value	New value
Target Selection	Old value 1 = First Echo 2 = Largest Echo 3 = First Moving Echo	New value
Target Threshold Mode	Old value 1 = Automatic 2 = Fixed	New value
Target Threshold Value	Old value Automatic = % of Peak Max Fixed = Value in Eng. Units	New value
Top Blocking Distance	Old value	New value
Turbulence	0 = None 1 = Light 2 = Medium 3 = Heavy	Corresponding Echo Strength
TVG End Location	Old value	New value
TVG End Value	Old value	New value
TVG Start Location	Old value	New value
TVG Start Value	Old value	New value

Complete Listing of Diagnostic Indicators including Analog Board Errors

Error Code	Diagnostic	Explanation
0	OK	
1	Software Error	Instruction execution traversed an incorrect path
2	RAM Error	run-time volatile memory test failed
3	ADC Error	Run-time analog-to-digital converter test failed
4	EEPROM Error	Unrecoverable checksum error in non-volatile memory
5	Firmware Conflict	Delay-locked loop malfunction
6	Analog Output Error	Measured loop current differs from commanded value
7	Coprocessor Error	Unrecoverable hardware error
8	Default Params	All parameters reset to default values
9	Spare	Reserved for future use
10	Spare	Reserved for future use
11	Spare	Reserved for future use
12	Too Many Echoes	Excessive number of waveform features are possible echoes
13	Safe Zone Alarm	Level is above Safe Zone end
14	Echo Lost	Echo from upper surface missing for longer than Echo Loss Delay
15	Spare	Reserved for future use
16	Config Conflict	Configuration conflict caused by incompatible parameter selections
17	High Volume Error	Calculated Volume exceeds maximum for vessel or custom table
18	High Flow Error	Calculated Flow exceeds maximum for flume or custom table
19	No Moving Echo	No moving echoes have been detected or selected
20	Initializing	System warming up, distance measurement not yet valid
21	Config Changed	A parameter(s) has recently been modified from the User Interface
22	Spare	Reserved for future use
23	High Electrical Temp	Present electronics temperature above maximum
24	Low Electric Temp	Present electronics temperature below minimum
25	Calibration Required	Distance calibration parameters are at default values
26	Echo Rejection Invalid	Previously stored Echo Rejection Curve invalidated by parameter change
27	Spare	Reserved for future use
28	Inferred Level	Typically this is caused when the Level target has been lost or has entered either the Top or Bottom Blocking Distance zones. If in the Top or Bottom Blocking Distance zones the transmitter will read Full (Top) or Empty (Bottom). The Level reading (and mA value) will never be higher than the value related to the Top Blocking Distance or lower than the value related to the Bottom Blocking Distance.
29	Adjust Analog Output	Loop trim parameters are at default values
30	Totalizer Data Lost	Totalizer data has been lost, restarted from zero
31	Low Supply Voltage	Power supply voltage inadequate to prevent brownout or reset
32	Spare	Reserved for future use
33	Max Jump Exceeded	Transmitter has jumped to an echo that exceeds the Max Distance Jump value from the previous echo.
34	Marginal Echo	Signal Margin is less than allowable minimum
35	High Surface Velocity	The measured Surface Velocity is greater than the Max Surface Velocity value derived from the Rate of Change parameter.
36	Spare	Reserved for future use
37	Seq Record	Instruction execution traversed a correct but unexpected path (formerly System Warning)

Service Policy

Owners of AMETEK LMS controls may request the return of a control or any part of a control for complete rebuilding or replacement. They will be rebuilt or replaced promptly. Controls returned under our service policy must be returned by Prepaid transportation. AMETEK LMS will repair or replace the control at no cost to the purchaser (or owner) other than transportation if:

1. Returned within the warranty period; and
2. The factory inspection finds the cause of the claim to be covered under the warranty.

If the trouble is the result of conditions beyond our control; or, is NOT covered by the warranty, there will be charges for labor and the parts required to rebuild or replace the equipment.

In some cases it may be expedient to ship replacement parts; or, in extreme cases a complete new control, to replace the original equipment before it is returned. If this is desired, notify the factory of both the model and serial numbers of the control to be replaced. In such cases, credit for the materials returned will be determined on the basis of the applicability of our warranty.

No claims for misapplication, labor, direct or consequential damage will be allowed.

Return Material Procedure

So that we may efficiently process any materials that are returned, it is essential that a "Return Material Authorization" (RMA) number be obtained from the factory, prior to the material's return. This is available through a AMETEK LMS local representative or by contacting the factory. Please provide the following information:

1. Company Name
2. Description of Material
3. Serial Number
4. Reason for Return
5. Application

Any unit that was used in a process must be properly cleaned in accordance with OSHA standards, before it is returned to the factory.

A Material Safety Data Sheet (MSDS) must accompany material that was used in any media.

All shipments returned to the factory must be by prepaid transportation.

All replacements will be shipped F.O.B. factory.

NOTE: See Electrostatic Discharge Handling Procedure on page 12.

