

Dell UltraSharp 27/32 4K Thunderbolt Hub Monitor

U2725QE/U3225QE

User's Guide

Notes, cautions, and warnings

 **NOTE:** A NOTE indicates important information that helps you make better use of your product.

 **CAUTION:** A CAUTION indicates either potential damage to hardware or loss of data and tells you how to avoid the problem.

 **WARNING:** A WARNING indicates a potential for property damage, personal injury, or death.

Contents

Safety instructions	5
About your monitor	6
Package contents	6
Product features	7
Operating system compatibility	10
Identifying parts and controls	10
Front view	10
Top view	11
Back view	12
Bottom view	13
Monitor specifications	15
Dell Display and Peripheral Manager (DDPM) for Windows	16
Resolution specifications	17
Supported video modes	17
Preset display modes	17
DisplayPort Video Source	19
USB-C DisplayPort-Alt. Mode Video Source	19
Thunderbolt 4 video source	21
Electrical specifications	22
Physical characteristics	23
Environmental characteristics	23
Pin assignments	24
Pin assignments - DisplayPort (in)	24
Pin assignments - DisplayPort (out)	25
Pin assignments - HDMI port	26
Pin assignments - Thunderbolt 4/USB-C port	27
Universal Serial Bus (USB)	28
RJ45 Port (Connector Side)	29
Plug and Play	31
LCD monitor quality and pixel policy	31
Ergonomics	32
Handling and moving your monitor	33
Maintenance guidelines	34
Cleaning your monitor	34
Setting up the monitor	35
Connecting the stand	35
Using the tilt, swivel, pivot and height adjustment	37
Tilt and swivel adjustment	37
Height adjustment	37
Pivot adjustment	38
Adjusting the rotation display settings of your system	38
Organizing your cables	39
Connecting your monitor	40
Dell Power Button Sync (DPBS)	44
Connecting the monitor for DPBS for the first time	46
Using DPBS function	47

Connecting the monitor for Thunderbolt 4 daisy chain function	48
Connect multiple Thunderbolt 4 monitors to one system	49
Securing your monitor using Kensington lock (optional)	51
Removing the monitor stand	52
VESA wall mounting (optional)	52
Operating the monitor	53
Turn on the monitor	53
Using the joystick control	53
Using the Menu Launcher	54
Using the navigation keys	56
Using the Main Menu	57
Using the OSD lock function	67
Initial Setup	70
OSD warning messages	71
Setting the maximum resolution	74
Multi-Monitor Sync (MMS)	75
Setting Multi-Monitor Sync (MMS)	76
Setting the KVM USB Switch	77
Setting the Auto KVM	80
Troubleshooting	82
Self-test	82
Built-in diagnostics	83
Common problems	84
Product-specific problems	85
Universal Serial Bus (USB) specific problems	86
Regulatory information	87
TCO Certified	87
FCC notices (U.S. only) and other regulatory information	87
EU product database for energy label and product information sheet	87
Contacting Dell	88

Safety instructions

Use the following safety guidelines to protect your monitor from potential damage and to ensure your personal safety. Unless otherwise noted, each procedure in this document assumes that you have read the safety information that shipped with your monitor.

NOTE: Before using the monitor, read the safety information that is shipped with your monitor and printed on the product. Keep the documentation at a secure location for future reference.

WARNING: Use of controls, adjustments or procedures other than those specified in this documentation may result in exposure to shock, electrical hazards and/or mechanical hazards.

CAUTION: The possible long-term effect of listening to audio at high volume through the headphones (on monitor that supports it) may cause damage to your hearing ability.

- Place the monitor on a solid surface and handle it carefully.
- The screen is fragile and can be damaged if dropped or hit with a sharp object.
- Ensure that your monitor is electrically rated to operate with the AC power available in your location.
- Keep the monitor in room temperature. Excessive cold or hot conditions can have an adverse effect on the liquid crystal of the display.
- Connect the power cable from the monitor to a wall outlet that is near and accessible. See [Connecting your monitor](#).
- Do not place and use the monitor on a wet surface or near water.
- Do not subject the monitor to severe vibration or high impact conditions. For example, do not place the monitor inside a car trunk.
- Unplug the monitor when it is going to be left unused for an extended period.
- To avoid electric shock, do not attempt to remove any cover or touch the inside of the monitor.
- Read these instructions carefully. Keep this document for future reference. Follow all warnings and instructions marked on product.
- Certain monitors can be wall mounted using the VESA mount that is sold separately. Ensure to use the correct VESA specifications as mentioned in the wall mounting section of the User's Guide.

For information about safety instructions, see the *Safety, Environmental and Regulatory Information (SERI)* document that is shipped with your monitor.







About your monitor

Package contents

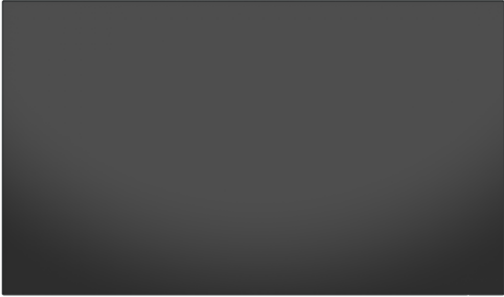
The following table provides the list of components that are shipped with your monitor. If any component is missing, contact Dell. For more information, see [Contacting Dell](#).

NOTE: Some items may be optional and may not ship with your monitor. Some features may not be available in certain countries.

Table 1. Monitor components and descriptions.

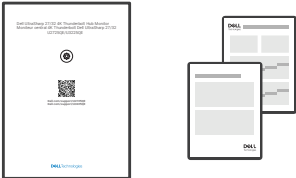
Component image	Component description
	Monitor
	Stand riser
	Stand base
	Power cord (varies by country)
	DisplayPort 1.4 cable (1.80 m) (DisplayPort to DisplayPort)
	USB-C to USB Type-A 10Gbps cable (1.0 m)
	Thunderbolt 4 40Gbps cable 40Gbps (1.0 m)
	<ul style="list-style-type: none">• QR Card• Safety, Environmental and Regulatory Information

Product features

The **Dell UltraSharp U2725QE/U3225QE** monitor has an active matrix, Thin-Film Transistor (TFT), Liquid Crystal Display (LCD), anti-static and LED backlight. The monitor has the following features:

- **U2725QE:** 68.47 cm (27.0 in.) active area display (Measured diagonally) 3840 x 2160 (16:9) resolution, plus full-screen support for lower resolutions.
- **U3225QE:** 80.01 cm (31.5 in.) active area display (Measured diagonally) 3840 x 2160 (16:9) resolution, plus full-screen support for lower resolutions.
- Wide viewing angles with 100% sRGB, 100% BT.709, 99% Display P3 and 99% DCI-P3 color with an average Delta E < 1.5.
- Tilt, swivel, pivot and height adjustment capabilities.
- Removable pedestal stand and Video Electronics Standards Association (VESA™) 100 mm mounting holes for flexible mounting solutions.
- Auto Brightness function automatically adjusts monitor brightness and color temperature based on the detected ambient light, and multiple Dell monitors with the Auto Brightness function could synchronize their brightness and color temperature level.
- Ultra-thin bezel minimizes the bezel gap during multi-monitor usage, enabling easier set up with an elegant viewing experience.
- Extensive digital connectivity with DP helps future-proof your monitor.
- Thunderbolt 4 to supply power to compatible notebook while receiving video signal.
- Thunderbolt 4 and RJ45 ports enable a single-cable, network-connected experience.
- Plug and play capability if supported by your computer.
- On-Screen Display (OSD) adjustments for ease of set-up and screen optimization.
- Power and OSD buttons lock.
- Security lock slot.
- ≤ 0.3 W in Off Mode.
- The monitor support VRR (Variable refresh rate) function, get higher frame rates and help reduce screen tearing in games.
- The monitor support DRR (Dynamic refresh rate)function, DRR works with all Windows11 tasks, allowing you to automatically increase the refresh rate (for a smoother experience)while using the PC or NB to writing or scrolling, and lower the refresh rate when you don't need it, which saves more power.
- Supports Picture by Picture (PBP) and Picture in Picture (PIP) Select mode.
- Supports Wake On Lan S3, S4/S5* and MAPT (MAC Address Pass Through).
- Allow user to switch USB KVM function in PBP mode.
- The monitor is designed with Dell Power Button Sync (DPBS) feature to control PC system power state from monitor power button.*
- The monitor allows multiple monitors that are daisy chained via DisplayPort to synchronize a pre-defined group of OSD settings in the background by Multi-Monitor Sync (MMS).
- Premium Panel Exchange for peace of mind.
- Optimize eye comfort with a flicker-free screen and low blue light feature to minimizes hazard blue light emission.
- Dell ComfortView Plus is an integrated low blue light screen feature that improves eye comfort by reducing potentially harmful blue light emissions without compromising color. Through ComfortView Plus technology, Dell has reduced harmful blue light exposure from ≤50% to ≤35%. This monitor is certified with TÜV Rheinland Eye Comfort 3.0 with a 5-star rating. It incorporates key technologies that also deliver a flicker-free screen, up to 120 Hz refresh rate, a color gamut of minimum 95% DCI-P3, color accuracy, and ambient light sensor performance. Dell ComfortView Plus feature is enabled by default on your monitor.
- This monitor uses a low blue light panel. When the monitor is reset to factory settings or default setting, it is in compliance with TÜV Rheinland's hardware low blue light certification.**

Blue light ratio:

The ratio of light in the range from 415nm-455nm compared to 400nm-500nm shall be less than 50%.

Table 2. Blue light ratio.

Category	Blue light ratio
1	≤20%
2	20% < R ≤ 35%
3	35% < R ≤ 50%

- Decreases the level of hazard blue light emitted from the screen to make viewing more comfortable for your eyes without distortion of color accuracy.
- The monitor adopts Flicker-Free technology, which clears the eye visible flicker, brings comfort viewing experience and preventing users suffer from eye strain and fatigue.

* For Dell systems that support this feature.

** This monitor is in compliance with TÜV Rheinland hardware low blue light certification under Category 2.

About TÜV Rheinland Eye Comfort 3.0

TÜV Rheinland Eye Comfort 3.0 certification program presents a consumer-friendly star rating scheme to the display industry promoting eye wellness from safety to eye care. Compared to existing certifications, the 5-star-rating program adds rigorous testing requirements on overall eye care attributes such as low blue-light, flicker-free, refresh rate, color gamut, color accuracy and ambient light sensor performance. It lays out requirement metrics and rates the product performance on five levels, and the sophisticated technical assessment process provides consumers and buyers with indicators that are easier to judge.

The eye wellness factors being considered remain constant, however, the standards for the various star ratings are different. The higher the star rating, the more stringent the standards. The table below lists the major eye comfort requirements which apply in addition to the basic eye comfort requirements (such as pixel density, uniformity of luminance and color, and freedom of movement).

For more information around **TÜV Eye Comfort certification** please refer to:

<https://www.tuv.com/world/en/eye-comfort.html>



Table 3. Eye Comfort 3.0 Requirements and Star Rating Scheme for Monitors.

Category	Test item	Star Rating Scheme		
		3-star	4-star	5-star
Eye Care	Low Blue Light	TÜV Hardware LBL Category III ($\leq 50\%$) or Software LBL solution ¹	TÜV Hardware LBL Category II ($\leq 35\%$) or Category I ($\leq 20\%$)	TÜV Hardware LBL Category II ($\leq 35\%$) or Category I ($\leq 20\%$)
	Flicker Free	TÜV Flicker Reduced or TÜV Flicker Free	TÜV Flicker Reduced or TÜV Flicker Free	Flicker Free
Ambient Light Management	Ambient Light Sensor performance	No sensor	No sensor	Ambient light sensor
	Intelligent CCT control	No	No	Yes
	Intelligent Luminance control	No	No	Yes
Image quality	Refresh Rate	$\geq 60\text{Hz}$	$\geq 75\text{Hz}$	$\geq 120\text{Hz}$
	Luminance uniformity	Luminance uniformity $\geq 75\%$		
	Color Uniformity	Color uniformity $\Delta u'v' \leq 0.02$		
	Freedom of movement	Luminance changes shall decrease less than 50%; The colour shift shall be less than 0.01		
	Gamma difference	Gamma difference $\leq \pm 0.2$	Gamma difference $\leq \pm 0.2$	Gamma difference $\leq \pm 0.2$
	Wide color gamut ²	NTSC ³ Min. 72% (CIE 1931) or sRGB ⁴ Min 95% (CIE 1931)	sRGB ⁴ Min. 95% (CIE 1931)	DCI-P3 ⁵ Min. 95% (CIE 1976) & sRGB ⁴ Min. 95% (CIE 1931) or Adobe RGB ⁶ Min. 95% (CIE 1931) & sRGB ⁴ Min. 95% (CIE 1931)
Eye Comfort User Guide	User guide	Yes	Yes	Yes
Remark	<p>¹ Software controls the blue light emission by reducing excessive blue light, resulting in a more yellow tone.</p> <p>² Color gamut describes the availability of colors in the display. Various standards were developed for specific purposes. 100% corresponds to the full color space as defined in the standard.</p> <p>³ NTSC stands for National Television Standards Committee, which developed a color space for the television system that is used in the United States.</p> <p>⁴ sRGB is a standard red, green, and blue color space that is in use on monitors, printers, and the World Wide Web.</p> <p>⁵ DCI-P3, short for Digital Cinema Initiatives - Protocol 3, is a color space used in digital cinema that encompasses a wider range of colors than the standard RGB color space.</p> <p>⁶ Adobe RGB is a color space created by Adobe Systems that encompasses a broader range of colors than the standard RGB color model, particularly in the cyans and greens.</p>			

Operating system compatibility

- Windows 10 and later*
- macOS 12* and macOS 13*

*The operating system compatibility on Dell and Alienware branded monitors may vary based on factors such as:

- Specific release date(s) when operating system versions, patches, or updates are available.
- Specific release date(s) when Dell and Alienware branded monitor firmware, software application, or driver updates are available on the Dell support website.

Identifying parts and controls

Front view

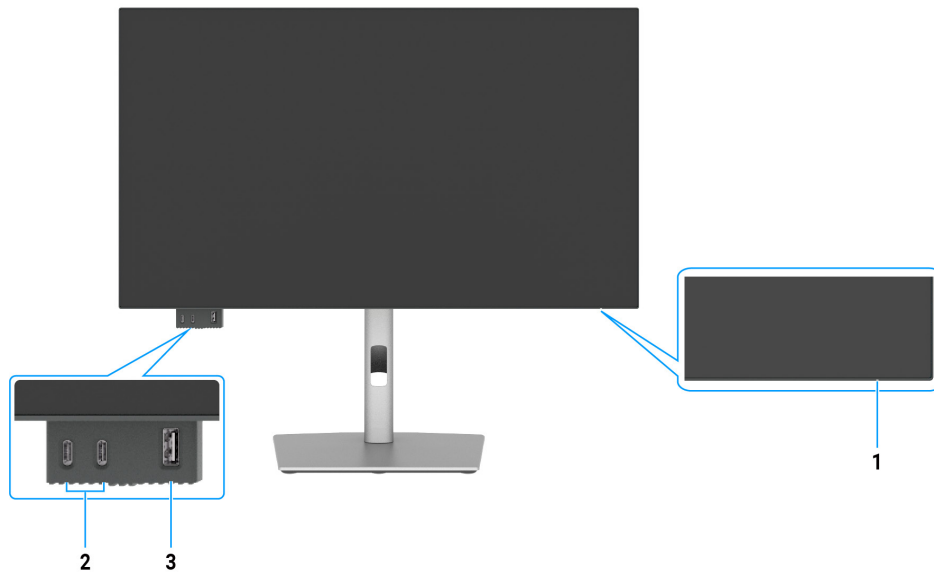

Figure 1. Front view of the monitor

Table 4. Components and descriptions.

Label	Description	Function
1	Power LED indicator	Solid white light indicates the monitor is turned on and functioning normally. Blinking white light indicates the monitor is in Standby Mode.
2	2 x USB-C 10Gbps downstream port with power charging (15W)	Connect your USB device. The USB-C port supports 5 V/3 A.
3	USB Type-A 10Gbps downstream port with BC1.2 5 V/1.5 A typical (2 A max) power charging (10W)	Connect your USB device. The USB port supports Battery Charging Rev. 1.2.

NOTE: You can use this port only after you have connected the USB cable (A to C or C to C) to the USB-C or Thunderbolt 4 upstream port at the rear of the monitor to the PC.

Top view

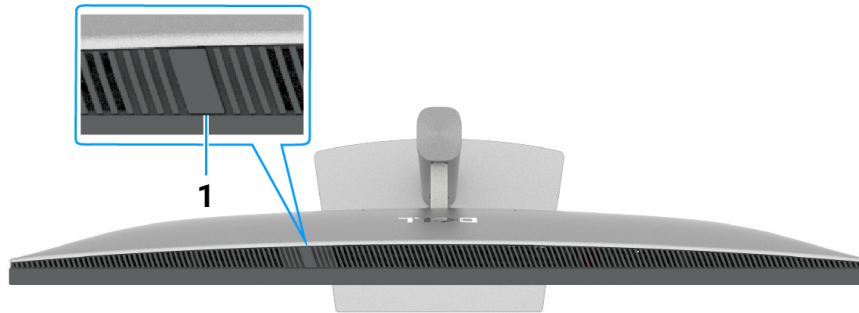

Figure 2. Top view of the monitor

Table 5. Components and descriptions.

Label	Description	Function
1	Ambient light sensor	Detects ambient light and adjusts the brightness of the display accordingly. For more information, see Auto Brightness and Auto Color Temp. i NOTE: If the Ambient light sensor detects abnormal change in the light level, see Ambient light detection anomaly .

Back view



Figure 3. Back view of the monitor

Table 6. Components and descriptions.

Label	Description	Function
1	VESA mounting holes (100 mm x 100 mm)-behind attached VESA cover	Wall mount monitor using VESA-compatible wall mount kit.
2	Regulatory information label	Lists the regulatory approvals.
3	Stand release button	Releases stand from the monitor.
4	Power On/Off button	To turn the monitor on or off.
5	Joystick	Use it to control the OSD menu. For more information, see Operating the monitor .
6	Regulatory label (including Mac address, Barcode, serial number, and Service Tag label)	Refer to this label if you need to contact Dell for technical support. The Service Tag is a unique alphanumeric identifier that enables Dell service technicians to identify the hardware components in your computer and access warranty information.
7	Cable-management slot	Use to organize cables by inserting them through the slot.

Bottom view

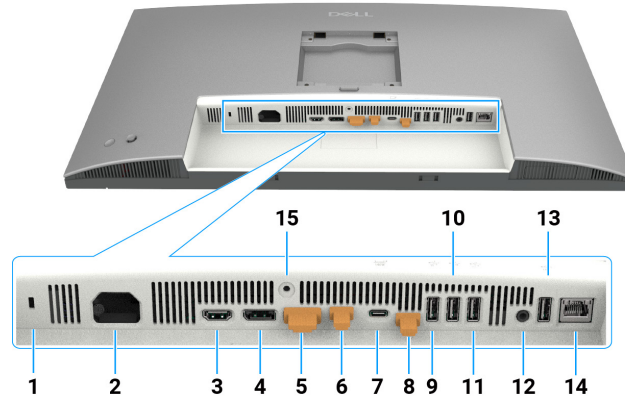















Figure 4. Bottom view of the monitor

Table 7. Components and descriptions.

Label	Description	Function
1	Security lock slot	Secures monitor with security cable lock (sold separately).
2	 Power connector	Connect the power cable.
3	 HDMI HDMI 2.1 port	Connect your computer with the HDMI cable.
4	 DisplayPort 1.4 port (in)	Connect your computer with the DisplayPort cable.
5	 DisplayPort 1.4 port (out) 	DP output for MST (Multi-Stream Transport) capable monitor. To enable MST, refer to instruction on section Connecting the monitor for DP MST function .
6	 Thunderbolt 4 downstream (Video + Data) 	Thunderbolt 4 downstream port suitable for video and USB data output under Daisy chain, Connecting the monitor for TBT daisy chain. NOTE: HDMI input is not supported video output in this port in KVM function. NOTE: This port is always active to transmit video and data of a Thunderbolt source connected to port 7. MST function must be turned on to enable this port to transmit DP or USB-C DP-Alt video connected to port 4 and port 7 respectively.
7	 140W Thunderbolt 4 upstream (Video + Data). Alternate mode with DisplayPort 1.4, Power Delivery up to 140 W	Connect to your computer using the Thunderbolt cable. The Thunderbolt 4 upstream offer the fastest transfer rate (USB 3.2 Gen 2), TBT mode and the alternate mode with DP 1.4 support the following, and 28 V/5 A, 20 V/4.5 A, 15 V/3 A, 9 V/3 A, 5 V/3 A. Maximum resolution of 3840 x 2160 at 120 Hz. This model will feature Thunderbolt 4 technology and will have a 140 W power delivery, it is recommended for use the following Dell's products that meet the fire enclosures. NOTE: Thunderbolt 4 upstream is not supported on Windows versions that are prior to Windows 10. NOTE: Power delivery supports a maximum of 140 W (28V5A) and requires devices to support USB PD EPR(extended power range), otherwise it can only support a maximum of 90 W (20V4.5A).
8	 USB-C upstream port (data only) 	Connect to your computer using the USB cable (Thunderbolt 4 cable, A to C or C to C). Once the USB cable is connected, you can use the USB downstream connectors on the monitor.

Label	Description	Function
9, 10, 11, 13	 Super speed USB 10 Gbps ports (4)	Connect your USB device. You can use these ports only after you have connected the USB cable (Thunderbolt 4 cable, A to C or C to C) from the computer to the monitor.
12	 Audio line-out port	Connect external speakers.*
14	 RJ45 connector (2.5G)	Connect Internet. You can surf Internet via RJ45 only after you have connected the USB cable (Thunderbolt 4 cable, A to C or C to C) from the computer to the monitor.
15	Stand lock	Lock the stand to the monitor using a M3 x 8 mm screw (screw not included).

* Headphone usage is not supported for the audio line out connector.

Monitor specifications

Table 8. Monitor specifications.

Specification	U2725QE	U3225QE
Screen type	Active matrix-TFT LCD	Active matrix-TFT LCD
Panel technology	In-Plane Switching (IPS) Black Technology	In-Plane Switching (IPS) Black Technology
Aspect ratio	16:9	16:9
Viewable image dimensions		
Diagonal	684.7 mm (27.0 in.)	800.1 mm (31.5 in.)
Active Area		
Horizontal	596.74 mm (23.49 in.)	697.31 mm (27.45 in.)
Vertical	335.66 mm (13.22 in.)	392.23 mm (15.44 in.)
Area	200301.74 mm ² (310.47 in. ²)	273505.90 mm ² (423.83 in. ²)
Pixel pitch		
Horizontal	0.1554 mm	0.18159 mm
Vertical	0.1554 mm	0.18159 mm
Pixel per inch (PPI)	163	140
Viewing angle		
Horizontal	178° (typical)	178° (typical)
Vertical	178° (typical)	178° (typical)
Brightness	450 cd/m ² (typical) 600 cd/m ² (HDR peak)	450 cd/m ² (typical) 600 cd/m ² (HDR peak)
Contrast ratio	3000:1 (typical)	3000:1 (typical)
Display screen coating	Anti-glare with hard-coating 3H	Anti-glare with hard-coating 3H
Backlight	LED Edgelight System	LED Edgelight System
Response Time (Gray to Gray)	5 ms (Fast mode) 8 ms (Normal mode)	5 ms (Fast mode) 8 ms (Normal mode)
Color depth	1.07 billion colors	1.07 billion colors
Color gamut	sRGB 100% (CIE 1931) (typical) DCI-P3 99% (CIE 1976) (typical)	sRGB 100% (CIE 1931) (typical) DCI-P3 99% (CIE 1976) (typical)
Calibration accuracy	Delta E <1.5 (average) (sRGB, BT.709, DCI-P3, Display P3)	Delta E <1.5 (average) (sRGB, BT.709, DCI-P3, Display P3)
HDR support	VESA DisplayHDR 600	VESA DisplayHDR 600
Connectivity	<ul style="list-style-type: none"> • 1 x DisplayPort 1.4 port with DSC support (DRR for Microsoft Windows) • 1 x DisplayPort 1.4 port out • 1 x HDMI port (Supports up to UHD 3840 x 2160 120Hz FRL, VRR as per specified in HDMI2.1)* • 1 x Thunderbolt 4 upstream port (DP1.4 (HDCP 2.2) with DSC support, PD: 140 W, 2/4 Lanes switching) – upstream • 1 x Thunderbolt 4 downstream port (Downstream, Daisy Chain, 15 W) • 1 x USB-C (USB 10Gbps KVM) upstream port • 1 x Analog 2.0 audio line out port (3.5 mm jack) • 4 x USB Type-A ports (USB 10Gbps) • 1 x RJ45 port Quick Access port: <ul style="list-style-type: none"> • 1 x USB Type-A 10Gbps with BC 1.2 • 2 x USB-C 10Gbps downstream 	<ul style="list-style-type: none"> • 1 x DisplayPort 1.4 port with DSC support (DRR for Microsoft Windows) • 1 x DisplayPort 1.4 port out • 1 x HDMI port (Supports up to UHD 3840 x 2160 120Hz FRL, VRR as per specified in HDMI2.1)* • 1 x Thunderbolt 4 upstream port (DP1.4 (HDCP 2.2) with DSC support, PD: 140 W, 2/4 Lanes switching) – upstream • 1 x Thunderbolt 4 downstream port (Downstream, Daisy Chain, 15 W) • 1 x USB-C (USB 10Gbps KVM) upstream port • 1 x Analog 2.0 audio line out (3.5 mm jack) • 4 x USB Type-A ports (USB 10Gbps) • 1 x RJ45 port Quick Access port: <ul style="list-style-type: none"> • 1 x USB Type-A 10Gbps with BC 1.2 • 2 x USB-C 10Gbps downstream
Border width (edge of monitor to active area)		
Top	7.85 mm (0.31 in.)	7.70 mm (0.30 in.)
Left/Right	7.85 mm (0.31 in.)	7.95 mm (0.31 in.)

Specification	U2725QE	U3225QE
Bottom	10.00 mm (0.39 in.)	10.40 mm (0.41 in.)
Adjustability		
Height adjustable stand	150.00 mm (5.91 in.)	150.00 mm (5.91 in.)
Tilt	-5° to 21°	-5° to 21°
Swivel	-45° to 45°	-30° to 30°
Pivot	-90° to 90°	-90° to 90°
Cable management	Yes	Yes
Dell Display and Peripheral Manager (DDPM) Compatibility	Easy Arrange and other key features	Easy Arrange and other key features
Security	Security lock slot (cable lock sold separately)	Security lock slot (cable lock sold separately)

* Not supporting the HDMI2.1 optional specification, including HDMI Ethernet Channel (HEC), Audio Return Channel (ARC), standard for 3D format and resolutions, standard for 4K digital cinema resolution, Enhanced audio return channel (eARC), Quick Media Switching (QMS), Quick Frame Transport (QFT), Auto Low Latency Mode (ALLM), Display Stream Compression (DSC), and Source-Based Tone Mapping (SBTM).

Dell Display and Peripheral Manager (DDPM) for Windows

DDPM is a software application that helps you set up and configure the Dell monitors and peripherals. Some of its features include:

1. Adjusting the monitor On-Screen Display (OSD) settings such as brightness, contrast, and resolution without needing to use the joystick on the monitor.
2. Arrange multiple applications on your screen by placing them into a template of your choice using **Easy Arrange**.
3. Assign applications or files to the partitions of **Easy Arrange**, save the layout as a profile, and restore the profile automatically with **Easy Arrange Memory** when needed.
4. Connect the Dell Monitor to multiple input sources and manage these video inputs using the **Input Source** feature.
5. Customize each application with its own distinct color mode using the **Color Preset** feature.
6. Replicate software application settings from one monitor to another identical monitor using the **Import/Export** application settings feature.
7. Receive notifications and update the firmware and software.
8. If the display supports the Keyboard Video Mouse (KVM) feature, you can set up and share the keyboard and mouse across connected computers using the **USB KVM** option.
9. Also, if the display supports the **Network KVM** feature, then you can share the keyboard and mouse across computers on the same network and transfer files between them.
10. A macOS version of DDPM software is also available for your monitor. For the list of displays that support DDPM macOS version, see the knowledge base article 000201067 at <https://www.dell.com/support>.

 **NOTE:** Some features of the DDPM mentioned above are available only on select monitor models. For more information about DDPM, and the recommended computer configuration to install it, go to <https://www.dell.com/support/ddpm>.

Resolution specifications

Table 9. Resolution specifications.

Specification	U2725QE	U3225QE
Horizontal frequency	30 kHz to 275 kHz	30 kHz to 275 kHz
Vertical refresh rate	48 Hz to 120 Hz	48 Hz to 120 Hz
Default preset resolution	3840 x 2160 at 60 Hz	3840 x 2160 at 60 Hz
Maximum preset resolution	3840 x 2160 at 120 Hz	3840 x 2160 at 120 Hz

Supported video modes

Table 10. Supported video modes.

Specification	U2725QE	U3225QE
Video display capabilities (HDMI & DisplayPort & Thunderbolt mode and alternate mode)	480p at 60 Hz 576p at 60 Hz 720p at 60 Hz 1080p at 60 Hz 2160p at 60 Hz	480p at 60 Hz 576p at 60 Hz 720p at 60 Hz 1080p at 60 Hz 2160p at 60 Hz

Preset display modes

Table 11. Preset display modes (U2725QE).

Display mode	Horizontal frequency (kHz)	Vertical frequency (Hz)	Pixel clock (MHz)	Sync polarity (Horizontal/Vertical)
VGA, 720 x 400	31.47	70.08	28.32	-/+
VGA, 640 x 480	31.47	59.94	25.18	-/-
VGA, 640 x 480	37.50	75.00	31.50	-/-
SVGA, 800 x 600	37.88	60.32	40.00	+/+
SVGA, 800 x 600	46.88	75.00	49.50	+/+
XGA, 1024 x 768	48.36	60.00	65.00	-/-
XGA, 1024 x 768	60.02	75.03	78.75	+/+
SXGA, 1152 x 864	67.50	75.00	108.00	+/+
SXGA, 1280 x 800	49.31	59.91	71.00	-/+
SXGA, 1280 x 1024	64.00	60.02	108.00	+/+
SXGA, 1280 x 1024	79.98	75.03	135.00	+/+
SXGA, 1600 x 900	60.00	60.00	108.00	-/-
WUXGA, 1600 x 1200	75.00	60.00	162.00	-/+
WSXGA+, 1680 x 1050	65.29	59.95	146.25	-/+
FHD, 1920 x 1080	67.50	60.00	148.50	-/+
FHD, 1920 x 1080	135.00	120.00	297.00	-/+
WUXGA, 1920 x 1200	74.56	59.89	193.25	-/+
QHD, 2560 x 1440	88.79	59.95	241.50	+/-
QHD, 2560 x 1440	183.00	120.00	497.75	+/+
UHD, 3840 x 2160	65.68	30.00	262.75	+/-
UHD 3840 x 2160 (DP)	133.31	60.00	533.25	+/-
UHD 3840 x 2160 (HDMI)	135.00	60.00	594.00	+/+
UHD 3840 x 2160	274.44	120.00	1097.75	+/-

Table 12. Preset display modes (U3225QE).

Display mode	Horizontal frequency (kHz)	Vertical frequency (Hz)	Pixel clock (MHz)	Sync polarity (Horizontal/Vertical)
VGA, 720 x 400	31.47	70.08	28.32	-/+
VGA, 640 x 480	31.47	59.94	25.18	-/-
VGA, 640 x 480	37.50	75.00	31.50	-/-
SVGA, 800 x 600	37.88	60.32	40.00	+/+
SVGA, 800 x 600	46.88	75.00	49.50	+/+
XGA, 1024 x 768	48.36	60.00	65.00	-/-
XGA, 1024 x 768	60.02	75.03	78.75	+/+
SXGA, 1152 x 864	67.50	75.00	108.00	+/+
SXGA, 1280 x 800	49.31	59.91	71.00	-/+
SXGA, 1280 x 1024	64.00	60.02	108.00	+/+
SXGA, 1280 x 1024	79.98	75.03	135.00	+/+
SXGA, 1600 x 900	60.00	60.00	108.00	-/-
WUXGA, 1600 x 1200	75.00	60.00	162.00	-/+
WSXGA+, 1680 x 1050	65.29	59.95	146.25	-/+
FHD, 1920 x 1080	67.50	60.00	148.50	-/+
FHD, 1920 x 1080	135.00	120.00	297.00	-/+
WUXGA, 1920 x 1200	74.56	59.89	193.25	-/+
QHD, 2560 x 1440	88.79	59.95	241.50	+/-
QHD, 2560 x 1440	183.00	120.00	497.75	+/+
UHD, 3840 x 2160	65.68	30.00	262.75	+/-
UHD 3840 x 2160 (DP)	133.31	60.00	533.25	+/-
UHD 3840 x 2160 (HDMI)	135.00	60.00	594.00	+/+
UHD 3840 x 2160	274.44	120.00	1097.75	+/-

DisplayPort Video Source

Table 13. DisplayPort Single-Stream Transport (SST) mode - Connect one Monitor.

Uplink Host Platform link training with first monitor	Upstream cable	Platform DSC	Monitor Max Resolution
DisplayPort (HBR3 DSC)	DisplayPort cable (USB data need connect upstream cable)	DSC1/2.4	4K 120 Hz 30 bit
DisplayPort (HBR2 no DSC)		DSC1/3	4K 120 Hz 30 bit
DisplayPort (HBR2 DSC)		NA	4K 60 Hz 30 bit
		DSC1/2.4	4K 120 Hz 24 bit
		DSC1/3	4K 120 Hz 30 bit

NOTE: Figure 30. Connecting the DisplayPort cable.

Table 14. DisplayPort Multi-Stream Transport (MST) modes-Connect two monitor.

Uplink Host Platform link training with first monitor	Upstream cable	Platform DSC	DUT1 MST status	Monitor Resolution	TBT out / DP out	Monitor2 Resolution
DisplayPort (HBR3 8.1 G DSC)	DisplayPort cable (USB data need connect upstream cable)	DSC1/2.4	MST ON	4K 120 Hz 24 bit	USB-C 10Gbps cable or TBT cable	4K 120 Hz 24 bit
		DSC1/3		4K 120 Hz 30 bit		4K 120 Hz 30 bit
DisplayPort (HBR2 5.4 G no DSC)		NA		4K 60 Hz 24 bit		FHD 60 Hz 24 bit
DisplayPort (HBR2 5.4 G DSC)		DSC1/2.4		4K 120 Hz 30 bit	DP cable (USB data need connect upstream cable)	2K 60 Hz 24 bit
DisplayPort (HBR3 8.1G DSC)		DSC1/3		4K 120 Hz 30 bit		4K 60 Hz 30 bit
		DSC1/2.4		4K 120 Hz 24 bit		4K 120 Hz 24 bit
		DSC1/3		4K 120 Hz 30 bit		4K 120 Hz 30 bit
DisplayPort (HBR2 5.4 G no DSC)		NA		4K 60 Hz 24 bit	4K 120 Hz 30 bit	FHD 60 Hz 24 bit
DisplayPort (HBR2 5.4 G DSC)		DSC1/2.4		4K 120 Hz 30 bit	4K 120 Hz 30 bit	2K 60 Hz 24 bit
		DSC1/3		4K 120 Hz 30 bit	4K 120 Hz 30 bit	4K 60 Hz 30 bit

NOTE: Figure 31. Connecting the monitor for DP Multi-Stream Transport (MST) function and Figure 32. Connecting the monitor for DP-TBT Multi-Stream Transport (MST) function.

USB-C DisplayPort-Alt. Mode Video Source

Table 15. High resolution(4Lane)-Connect one monitor.

Uplink Host Platform link training with first monitor	Upstream cable	Platform DSC	Monitor Max Resolution
USB-C (Alt Mode HBR3 8.1 G) (4Lane DSC)	USB-C 10Gbps cable or TBT cable	DSC1/2.4	4K 120 Hz 30 bit (USB 2.0)
		DSC1/3	4K 120 Hz 30 bit (USB 2.0)
USB-C (Alt Mode HBR2 5.4) (4Lane DSC)		DSC1/2.4	4K 120 Hz 30 bit (USB 2.0)
		DSC1/3	4K 120 Hz 30 bit (USB 2.0)
USB-C (Alt Mode HBR2 5.4) (4Lane no DSC)		NA	4K 60 Hz 30 bit (USB 2.0)

Table 16. High resolution(4Lane)-Connect two monitor.

Uplink Host Platform link training with first monitor	Upstream cable	Platform DSC	DUT1 MST status	Monitor Resolution	TBT out / DP out	Monitor2 Resolution
USB-C (Alt Mode HBR3 8.1G)(4Lane DSC)	USB-C 10Gbps cable or TBT cable	DSC1/2.4	MST ON	4K 120 Hz 24 bit (USB 2.0)	USB-C 10Gbps cable or TBT cable	4K 120 Hz 24 bit (USB 2.0)
		DSC1/3		4K 120 Hz 30 bit (USB 2.0)		4K 120 Hz 30 bit (USB 2.0)
USB-C (Alt Mode HBR2 5.4 G)(4Lane no DSC)		NA		4K 60 Hz 24 bit (USB 2.0)		FHD 60 Hz 24 bit (USB 2.0)
		DSC1/2.4		4K 120 Hz 30 bit (USB 2.0)		2K 60 Hz 24 bit (USB 2.0)
USB-C (Alt Mode HBR2 5.4 G)(4Lane DSC)		DSC1/3		4K 120 Hz 30 bit (USB 2.0)	4K 60 Hz 30 bit (USB 2.0)	
USB-C (Alt Mode HBR3 8.1G)(4Lane DSC)		DSC1/2.4		4K 120 Hz 24 bit (USB 2.0)	DP cable (USB data need connect upstream cable)	4K 120 Hz 24 bit (USB 2.0)
		DSC1/3		4K 120 Hz 30 bit (USB 2.0)		4K 120 Hz 30 bit (USB 2.0)
USB-C (Alt Mode HBR2 5.4 G)(4Lane no DSC)		NA		4K 60 Hz 24 bit (USB 2.0)		FHD 60 Hz 24 bit (USB 2.0)
		DSC1/2.4		4K 120 Hz 30 bit (USB 2.0)		2K 60 Hz 24 bit (USB 2.0)
USB-C (Alt Mode HBR2 5.4 G)(4Lane DSC)		DSC1/3		4K 120 Hz 30 bit (USB 2.0)		4K 60 Hz 30 bit (USB 2.0)

Table 17. High Data Speed(2Lane)-Connect one monitor.

Uplink Host Platform link training with first monitor	Upstream cable	Platform DSC	Monitor Max Resolution
USB-C (Alt Mode HBR3 8.1G)(2Lane DSC)	USB-C 10Gbps cable or TBT cable	DSC1/2.4	4K 120 Hz 24 bit (USB 3.0)
		DSC1/3	4K 120 Hz 30 bit (USB 3.0)
USB-C (Alt Mode HBR2 5.4 G)(2Lane no DSC)		NA	2K 60 Hz 24 bit (USB 3.0)
USB-C (Alt Mode HBR2 5.4 G)(2Lane DSC)		DSC1/2.4	4K 60 Hz 30 bit (USB 3.0)
		DSC1/3	

Table 18. High Data Speed(2Lane)-Connect two monitor.

Uplink Host Platform link training with first monitor	Upstream cable	Platform DSC	DUT1 MST status	Monitor Resolution	TBT out / DP out	Monitor2 Resolution
USB-C (Alt Mode HBR3 8.1 G)(2Lane DSC)	USB-C 10 Gbps cable or TBT cable	DSC1/2.4	MST ON	4K 60 Hz 24 bit (USB 3.0)	USB-C 10Gbps cable or TBT cable	4K 60 Hz 24 bit(USB 3.0)
		DSC1/3		4K 60 Hz 30 bit (USB 3.0)		4K 60 Hz 30 bit (USB 3.0)
NA		FHD 60 Hz 24 bit (USB 3.0)		FHD 60 Hz 24 bit(USB 3.0)		
USB-C (Alt Mode HBR2 5.4 G)(2Lane no DSC)		DSC1/2.4		4K 60 Hz 30 bit(USB 3.0)	DP cable (USB data need connect upstream cable)	4K 60 Hz 24 bit(USB 3.0)
USB-C (Alt Mode HBR2 5.4 G)(2Lane DSC)		DSC1/3		4K 60 Hz 24 bit(USB 3.0)		4K 60 Hz 30 bit(USB 3.0)
USB-C (Alt Mode HBR3 8.1 G)(2Lane DSC)		DSC1/2.4		4K 60 Hz 30 bit(USB 3.0)		4K 60 Hz 24 bit(USB 3.0)
USB-C (Alt Mode HBR3 8.1 G)(2Lane DSC)		DSC1/3		4K 60 Hz 24 bit(USB 3.0)		4K 60 Hz 30 bit(USB 3.0)
USB-C (Alt Mode HBR2 5.4 G)(2Lane no DSC)		NA		FHD 60 Hz 24 bit(USB 3.0)		FHD 60 Hz 24 bit(USB 3.0)
USB-C (Alt Mode HBR2 5.4 G)(2Lane DSC)		DSC1/2.4		4K 60 Hz 30 bit(USB 3.0)		FHD 60 Hz 24 bit(USB 3.0)
USB-C (Alt Mode HBR2 5.4 G)(2Lane DSC)		DSC1/3		4K 60 Hz 30 bit(USB 3.0)	FHD 60 Hz 24 bit(USB 3.0)	

Thunderbolt 4 video source

Table 19. Thunderbolt 4 for one monitor.

Uplink Host Platform link training with first monitor	Upstream cable	Platform DSC	Monitor Max Resolution
TBT4	Thunderbolt 4 Active/passive cable (40G) or USB-C 10Gbps cable	DSC1/2.4	4K 120 Hz 30 bit (USB 3.0)
		DSC1/3	4K 120 Hz 30 bit (USB 3.0)

NOTE: Figure 33. Connecting the Thunderbolt 4 cable.

Table 20. Thunderbolt 4 for daisy chain-Connect two monitor.

Uplink Host Platform link training with first monitor	Upstream cable	Platform DSC	DUT1 MST status	Monitor Resolution	TBT out / DP out	Monitor2 Resolution
TBT4	Thunderbolt 4 active/passive cable (40G)	DSC1/2.4	Not applicable	4K 120 Hz 30 bit (USB 3.0) (HBR2 4L)	Thunderbolt 4 active/passive Cable (40G) or USB-C 10Gbps cable	4K 120 Hz 30 bit (USB 3.0) (HBR2 4L)
		DSC1/3				4K 120 Hz 30 bit (USB 3.0)
	USB-C 10Gbps cable	DSC1/2.4		DP cable (USB data need connect upstream cable)	not support	
		DSC1/3			4K 120 Hz 24 bit (USB 3.0)	
	Thunderbolt 4 active/passive cable (40G)	DSC1/2.4			4K 120 Hz 30 bit (USB 3.0) (HBR3 4L)	4K 120 Hz 30 bit (USB 3.0)
		DSC1/3			4K 120 Hz 30 bit (USB 3.0)	2K 60 Hz 24 bit (USB 3.0)
	USB-C 10Gbps cable	DSC1/2.4		4K 60 Hz 30 bit (USB 3.0)	4K 60 Hz 30 bit (USB 3.0)	
		DSC1/3		4K 60 Hz 30 bit (USB 3.0)	4K 60 Hz 30 bit (USB 3.0)	

NOTE: Figure 34. Connecting the Monitor for Thunderbolt 4 daisy chain function-1 and Figure 35. Connecting the Monitor for TBT-DP daisy chain function.

Table 21. Thunderbolt 4 for daisy chain-Connect three monitor.

Uplink Host Platform link training with first monitor	Upstream cable	Platform DSC	DUT1 MST status	Monitor1 Resolution	Monitor1 TBT out cable	Monitor2 Resolution
TBT4	Thunderbolt 4 active/passive cable (40G)	DSC1/2.4	MST ON	4K 120 Hz 30 bit (USB 3.0) (HBR3 4L)	Thunderbolt 4 active/passive cable (40G) or USB-C 10Gbps cable	4K 60 Hz 30 bit (USB 3.0) (HBR 4L)
		DSC1/3				
		NA			Monitor1 DP out cable	Monitor3 Resolution
		DSC1/2.4			DP cable	4K 120 Hz 24 bit (USB 3.0)
		DSC1/3				4K 120 Hz 30 bit (USB 3.0)

NOTE: Figure 36. Connecting the Monitor for TBT-DP daisy chain function-2.

Electrical specifications

Table 22. Electrical specifications.

Specification	U2725QE	U3225QE
Video input signals	<ul style="list-style-type: none"> Digital video signal for each differential line Per differential line at 100 ohm impedance DisplayPort/HDMI/Thunderbolt 4 signal input support 	<ul style="list-style-type: none"> Digital video signal for each differential line Per differential line at 100 ohm impedance DisplayPort/HDMI/Thunderbolt 4 signal input support
Input voltage/frequency/current	100-240 VAC / 50 or 60 Hz ± 3 Hz / 4 A (maximum)	100-240 VAC / 50 or 60 Hz ± 3 Hz / 4.2 A (maximum)
Inrush current	120 V: 42 A (maximum) 240 V: 80 A (maximum) Inrush current is measured at an ambient temperature of 0°C (cold start).	120 V: 42 A (maximum) 240 V: 80 A (maximum) Inrush current is measured at an ambient temperature of 0°C (cold start).
Power Consumption	0.3 W (Off Mode) ¹ 0.5 W (Standby Mode) ¹ 1.5 W (Networked standby Mode) ¹ 25.4 W (On Mode) ¹ 325 W (maximum) ² 27.5 W (P _{on}) ³ 92 kWh (TEC) ³	0.3 W (Off Mode) ¹ 0.5 W (Standby Mode) ¹ 1.5 W (Networked standby Mode) ¹ 30.5 W (On Mode) ¹ 335 W (maximum) ² 30.4 W (P _{on}) ³ 100.5 kWh (TEC) ³

¹ As defined in EU 2019/2021 and EU 2019/2013.

² Maximum brightness and contrast setting with maximum power loading on all USB ports.

³ P_{on}: Power consumption of On Mode as defined in Energy Star 8.0 version.

TEC: Total energy consumption in kWh as defined in Energy star 8.0 version.

This document is informational only and reflects laboratory performance. Your product may perform differently, depending on the software, components and peripherals you ordered and shall have no obligation to update such information. Accordingly, the customer should not rely upon this information in making decisions about electrical tolerances or otherwise. No warranty as to accuracy or completeness is expressed or implied.

NOTE: This monitor is ENERGY STAR certified. 

This product qualifies for ENERGY STAR in the factory default settings which can be restored by "Factory Reset" function in the OSD menu. Changing the factory default settings or enabling other features may increase power consumption that could exceed the ENERGY STAR specified limit.

Physical characteristics

Table 23. Physical characteristics.

Specification	U2725QE	U3225QE
Dimensions (with stand)		
Height (extended)	535.68 mm (21.09 in.)	618.94 mm (24.37 in.)
Height (compressed)	385.68 mm (15.18 in.)	468.94 mm (18.46 in.)
Width	612.44 mm (24.11 in.)	713.20 mm (28.08 in.)
Depth	189.00 mm (7.44 in.)	215.00 mm (8.46 in.)
Dimensions (without stand)		
Height	353.51 mm (13.92 in.)	410.34 mm (16.16 in.)
Width	612.44 mm (24.11 in.)	713.20 mm (28.08 in.)
Depth	55.60 mm (2.19 in.)	57.50 mm (2.26 in.)
Stand dimensions		
Height (extended)	428.30 mm (16.86 in.)	483.30 mm (19.03 in.)
Height (compressed)	381.50 mm (15.02 in.)	436.60 mm (17.19 in.)
Width	272.80 mm (10.74 in.)	287.50 mm (11.32 in.)
Depth	189.00 mm (7.44 in.)	215.00 mm (8.46 in.)
Base	272.80 mm x 189.00 mm (10.74 in. x 7.44 in.)	287.50 mm x 215.00 mm (11.32 in. x 8.46 in.)
Weight		
Weight with packaging	9.73 kg (21.45 lb)	13.39 kg (29.52 lb)
Weight with stand assembly and cables	7.06 kg (15.56 lb)	9.34 kg (20.59 lb)
Weight without stand assembly (For wall mount or VESA mount considerations - no cables)	5.22 kg (11.51 lb)	6.52 kg (14.37 lb)
Weight of stand assembly	1.52 kg (3.35 lb)	2.50 kg (5.51 lb)

Environmental characteristics

Table 24. Environmental characteristics.

Specification	U2725QE	U3225QE
Temperature		
Operating	0°C to 40°C (32°F to 104°F)	0°C to 40°C (32°F to 104°F)
Non-operating	-20°C to 60°C (-4°F to 140°F)	-20°C to 60°C (-4°F to 140°F)
Humidity		
Operating	10% to 80% (non-condensing)	10% to 80% (non-condensing)
Non-operating	5% to 90% (non-condensing)	5% to 90% (non-condensing)
Altitude		
Operating	5,000 m (16,404 ft) (maximum)	5,000 m (16,404 ft) (maximum)
Non-operating	12,192 m (40,000 ft) (maximum)	12,192 m (40,000 ft) (maximum)
Thermal dissipation	1108.9 BTU/hour (maximum) 86.7 BTU/hour (on mode)	1143.0 BTU/hour (maximum) 104.1 BTU/hour (on mode)
Compliant Standards	<ul style="list-style-type: none"> ENERGY STAR certified monitor EPEAT registered where applicable. EPEAT registration varies by country. See EPEAT for registration status by country. TCO Certified & TCO Certified Edge. RoHS Compliant. BFR/PVC free monitor (excluding external cables). Arsenic-free glass and Mercury-free for the panel only. 	

Pin assignments

Pin assignments - DisplayPort (in)

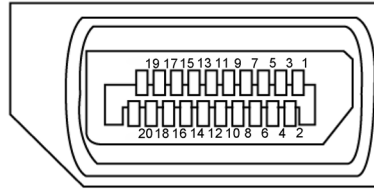

Figure 5. DisplayPort (in)

Table 25. DisplayPort (in).

Pin number	20-pin side of the connected signal cable
1	ML3(n)
2	GND
3	ML3(p)
4	ML2(n)
5	GND
6	ML2(p)
7	ML1(n)
8	GND
9	ML1(p)
10	ML0(n)
11	GND
12	ML0(p)
13	CONFIG1
14	CONFIG2
15	AUX CH (p)
16	GND
17	AUX CH (n)
18	Hot Plug Detect
19	Return
20	DP_PWR

Pin assignments - DisplayPort (out)

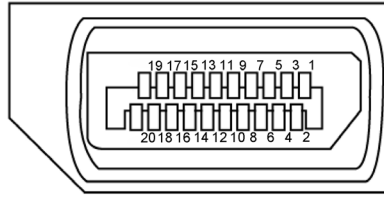

Figure 6. DisplayPort (out)

Table 26. DisplayPort (out)

Pin number	20-pin side of the connected signal cable
1	ML0(p)
2	GND
3	ML0(n)
4	ML1(p)
5	GND
6	ML1(n)
7	ML2(p)
8	GND
9	ML2(n)
10	ML3(p)
11	GND
12	ML3(n)
13	CONFIG1
14	CONFIG2
15	AUX CH(p)
16	GND
17	AUX CH(n)
18	Hot Plug Detect
19	Return
20	DP_PWR

Pin assignments - HDMI port

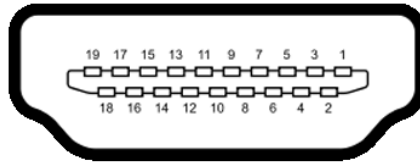

Figure 7. HDMI port

Table 27. HDMI port

Pin number	19-pin side of the connected signal cable
1	TMDS DATA 2+
2	TMDS DATA 2 SHIELD
3	TMDS DATA 2-
4	TMDS DATA 1+
5	TMDS DATA 1 SHIELD
6	TMDS DATA 1-
7	TMDS DATA 0+
8	TMDS DATA 0 SHIELD
9	TMDS DATA 0-
10	TMDS CLOCK+
11	TMDS CLOCK SHIELD
12	TMDS CLOCK-
13	CEC
14	Reserved (N.C. on device)
15	DDC CLOCK (SCL)
16	DDC DATA (SDA)
17	DDC/CEC Ground
18	+5 V POWER
19	HOT PLUG DETECT

Pin assignments - Thunderbolt 4/USB-C port

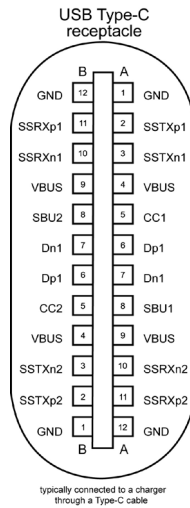

Figure 8. Thunderbolt 4/USB-C port

Table 28. Thunderbolt 4/USB-C port.



Pin	Signal	Pin	Signal
A1	GND	B12	GND
A2	SSTXp1	B11	SSRXp1
A3	SSTXn1	B10	SSRXn1
A4	VBUS	B9	VBUS
A5	CC1	B8	SBU2
A6	Dp1	B7	Dn1
A7	Dn1	B6	Dp1
A8	SBU1	B5	CC2
A9	VBUS	B4	VBUS
A10	SSRXn2	B3	SSTXn2
A11	SSRXp2	B2	SSTXp2
A12	GND	B1	GND

Universal Serial Bus (USB)

This section gives you information about the USB ports available on your display.

Your monitor has the following USB ports:

- 1 Thunderbolt 4 upstream port - at rear
- 1 Thunderbolt 4 downstream port - at rear
- 1 USB-C upstream port (data only) - at rear
- 2 USB-C downstream port - at Quick Access
- 5 USB Type-A 10Gbps downstream ports- 4 at rear, 1 at Quick Access

i NOTE: Up to 2 A on USB downstream port (port with  icon) with BC 1.2 compliance devices, this port at Quick Access; up to 3 A on USB-C downstream port (port with  icon) with 5 V/3 A compliance devices.

i NOTE: The monitor's USB ports work only when the monitor is on or in Standby Mode. On in Standby Mode, if the USB cable (A to C or C to C) is plugged in, the USB ports can work normally. Otherwise, follow the OSD setting of Other USB Charging, if the setting is "On in Standby Mode" then USB work normally, otherwise USB is disabled. If you turn off the monitor and then turn it on, the attached peripherals may take a few seconds to resume normal functionality.

Table 29. Transfer speed, data rate and common power consumption of USB ports.

Transfer speed	Data rate	Common power consumption (each port)
USB 5 Gbps/USB 10 Gbps	5 Gbps/10 Gbps	4.5 W
USB 2.0*	480 Mbps	4.5 W
USB 1.0*	12 Mbps	4.5 W

* Device speed when High Resolution is selected.

Table 30. Universal Serial Bus (USB).

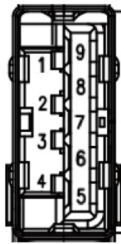

Figure 9. USB Type-A 10Gbps downstream port (bottom)

Pin number	Signal name
1	VBUS
2	D-
3	D+
4	GND
5	StdA_SSRX-
6	StdA_SSRX+
7	GND_DRAIN
8	StdA_SSTX-
9	StdA_SSTX+
Shell	Shield

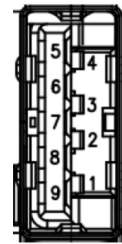

Figure 10. USB Type-A 10Gbps downstream port (rear)

Pin number	Signal name
1	VBUS
2	D-
3	D+
4	GND
5	StdA_SSRX-
6	StdA_SSRX+
7	GND_DRAIN
8	StdA_SSTX-
9	StdA_SSTX+
Shell	Shield

Thunderbolt 4 upstream

- Video DisplayPort 1.4
- Video Thunderbolt 4
- Data USB 10Gbps
- Power Delivery (PD) Up to 140 W

Thunderbolt 4 downstream

- Video DisplayPort 1.4
- Video Thunderbolt 4
- Data USB 10Gbps
- Power Delivery (PD) Up to 15 W

RJ45 Port (Connector Side)

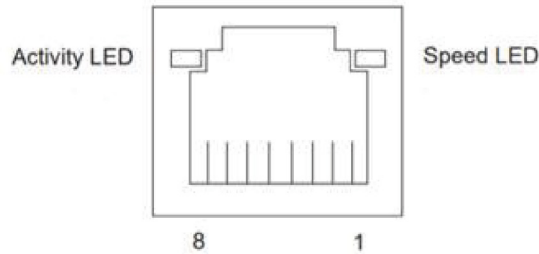

Figure 11. RJ45 Port (Connector Side)

Table 31. Port (Connector Side).

Pin No.	10BASE-T 100BASE-T	1000BASE-T 2500BASE-T
1	Transmit+	BI_DA+
2	Transmit-	BI_DA-
3	Receive+	BI_DB+
4	Unused	BI_DC+
5	Unused	BI_DC-
6	Receive-	BI_DB-
7	Unused	BI_DD+
8	Unused	BI_DD-

Driver installation

Install the Realtek USB GBE Ethernet Controller Driver available for your system. This is available for download at [Dell Support Site](#) under the “Driver and download” section.

Network (RJ45) data rate via USB-C max speed is 2.5 Gbps.

Table 32. Wake-on-LAN behavior.

Computer power save state	System behavior after receiving Wake-on-LAN (WOL) command
Modern Standby (S0ix)	The computer and Monitor remain in Standby mode but the network communication is enabled.
Standby/Sleep (S3)	Both computer and monitor are turned on.
Hibernate (S4)	Both computer and monitor are turned on.
OFF/Shutdown (S5)	Both computer and monitor are turned on.

- NOTE:** The computer BIOS must be configured to enable WOL function first.
- NOTE:** This LAN port is 2.5GBase-T IEEE 802.3az compliant, supporting Mac Address (Printed on model label) Pass-thru (MAPT), Wake-on-LAN (WOL) from standby mode (S3) and UEFI* PXE Boot function [UEFI PXE Boot is not supported on Dell Desktop PC’s (except for OptiPlex 7090/3090 Ultra Desktop)], these 3 features depend on BIOS settings and operating system versions. The functionality may vary with non-Dell PCs.
*UEFI stands for Unified Extensible Firmware Interface.
- NOTE:** WOL S4 and WOL S5 are only capable with Dell Systems that support DPBS and are with Thunderbolt/USB-C® (MFDP) interface connection.
- NOTE:** Any issue that is related to WOL, users should debug the computer without a monitor. After the problem is solved, then connect to the monitor.

RJ45 Connector LED status:

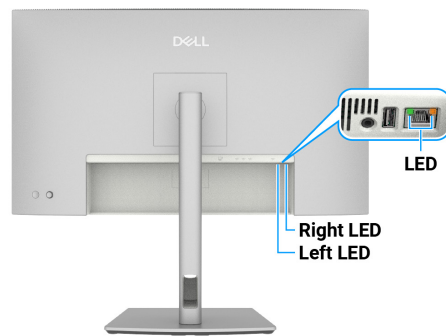

Figure 12. RJ45 LED color

Table 33. RJ45 LED color.

LED	Color	Description
Right LED	Amber or Green	Speed indicator: <ul style="list-style-type: none">• Amber On - 1000 Mbps/2.5 Gbps• Green On - 100 Mbps• Off - 10 Mbps
Left LED	Green	Link / Activity indicator: <ul style="list-style-type: none">• Blinking - Activity on the port.• Green On - Link is being established.• Off - Link is not established.

NOTE: RJ45 cable is not a standard in-box accessory.

Plug and Play

You can connect the monitor to any Plug and Play compatible computer. The monitor automatically provides the computer with its Extended Display Identification Data (EDID) using Display Data Channel (DDC) protocols so that the computer can configure itself and optimize the monitor settings. Most monitor installations are automatic; you can select different settings as required. For more information about changing the monitor settings, see [Operating the monitor](#).

LCD monitor quality and pixel policy

During the LCD monitor manufacturing process, it is not uncommon for one or more pixels to become fixed in an unchanging state, which are hard to see and do not affect the display quality or usability. For more information on Dell Monitor Quality and Pixel Policy, see [Dell Display Pixel Guidelines](#) at [Dell Support Site](#).

Ergonomics

⚠ **CAUTION: Improper or prolonged usage of keyboard may result in injury.**

⚠ **CAUTION: Viewing the monitor screen for extended periods of time may result in eye strain.**

For comfort and efficiency, observe the following guidelines when setting up and using your computer workstation:

- Position your computer so that the monitor and keyboard are directly in front of you as you work. Special shelves are commercially available to help you correctly position your keyboard.
- To reduce the risk of eye strain and neck/arm/back/shoulder pain from using the monitor for long periods of time, we suggest you to:
 1. Set the distance of the screen between 20 to 28 in. (50 - 70 cm) from your eyes.
 2. Blink frequently to moisten your eyes or wet your eyes with water after prolonged usage of the monitor.
 3. Take regular and frequent breaks for 20 minutes every two hours.
 4. Look away from your monitor and gaze at a distant object at 20 feet away for at least 20 seconds during the breaks.
 5. Perform stretches to relieve tension in the neck, arm, back, and shoulders during the breaks.
- Make sure that the monitor screen is at eye level or slightly lower when you are sitting in front of the monitor.
- Adjust the tilt of the monitor, its contrast, and brightness settings.
- Adjust the ambient lighting around you (such as overhead lights, desk lamps, and the curtains or blinds on nearby windows) to minimize reflections and glare on the monitor screen.
- Use a chair that provides good lower-back support.
- Keep your forearms horizontal with your wrists in a neutral, comfortable position while using the keyboard or mouse.
- Always leave space to rest your hands while using the keyboard or mouse.
- Let your upper arms rest naturally on both sides.
- Ensure that your feet are resting flat on the floor.
- When sitting, make sure that the weight of your legs is on your feet and not on the front portion of your seat. Adjust your chair's height or use a footrest if necessary to maintain a proper posture.
- Vary your work activities. Try to organize your work so that you do not have to sit and work for extended periods of time. Try to stand or get up and walk around at regular intervals.
- Keep the area under your desk clear of obstructions and cables or power cords that may interfere with comfortable seating or present a potential trip hazard.

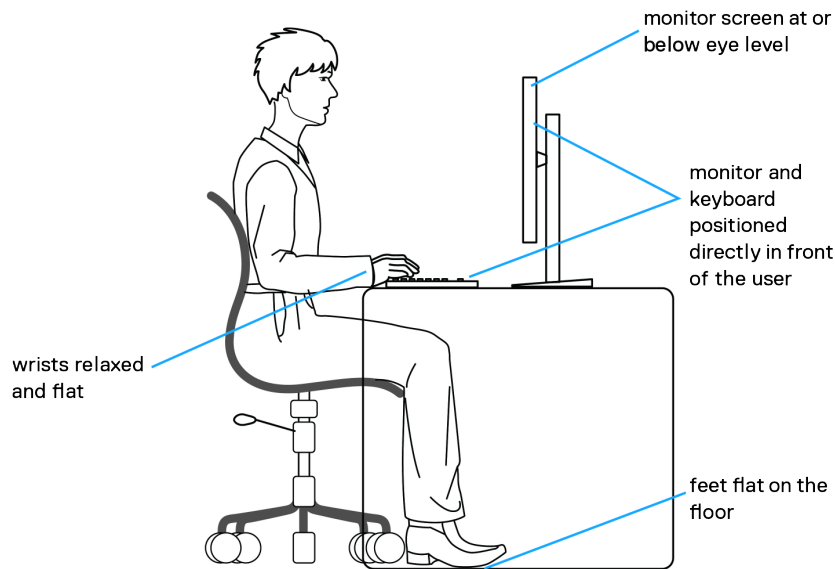

Figure 13. Ergonomics or comfort and efficiency

Handling and moving your monitor

To ensure the monitor is handled safely when lifting or moving it, follow the guidelines mentioned below:

- Before moving or lifting the monitor, turn off your computer and the monitor.
- Disconnect all cables from the monitor.
- Place the monitor in the original box with the original packing materials.
- Hold the bottom edge and the side of the monitor firmly without applying excessive pressure when lifting or moving the monitor.

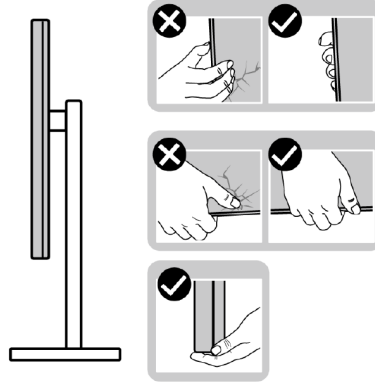

Figure 14. Moving or lifting the monitor

- When lifting or moving the monitor, ensure the screen is facing away from you and do not press on the display area to avoid any scratches or damage.

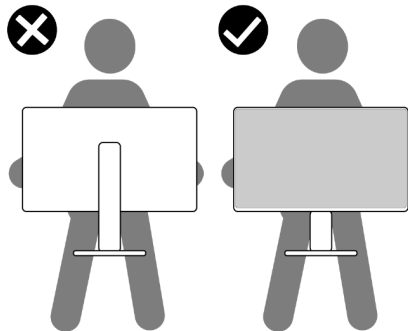

Figure 15. Ensure the screen is facing away from you

- When transporting the monitor, avoid any sudden shock or vibration to it.
- When lifting or moving the monitor, do not turn the monitor upside down while holding the stand base or stand riser. This may result in accidental damage to the monitor or cause personal injury.

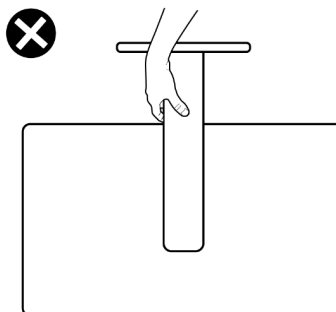

Figure 16. Do not turn the monitor upside down

Maintenance guidelines

Cleaning your monitor

⚠ WARNING: Before cleaning the monitor, unplug the monitor power cable from the electrical outlet.

⚠ CAUTION: Read and follow the [Safety instructions](#) before cleaning the monitor.

For best practices, follow the instructions in the list below when unpacking, cleaning, or handling your monitor:

- Use a clean cloth that is slightly dampened with water to clean the stand assembly, the screen, and the chassis of your Dell monitor. If available, use a screen-cleaning tissue or solution suitable for cleaning Dell monitors.
- After cleaning the surface of the table, ensure that it is thoroughly dry and free from any moisture or cleaning agent before placing your Dell monitor on it.
- ⚠ CAUTION:** Do not use detergents or other chemicals such as benzene, thinner, ammonia, abrasive cleaners, alcohol, or compressed air.
- ⚠ WARNING:** Do not directly spray the cleaning solution or even water directly on the surface of the monitor. Doing so will allow liquids to accumulate at the bottom of the display panel and corrode the electronics resulting in permanent damage. Instead, apply the cleaning solution or water to a soft cloth and then clean the monitor.
- ⚠ CAUTION:** Using chemicals for cleaning may cause changes in the appearance of the monitor, such as color fading, milky film on the monitor, deformation, uneven dark shade, and peeling of screen area.
- i NOTE:** Monitor damages due to improper cleaning methods and the use of benzene, thinner, ammonia, abrasive cleaners, alcohol, compressed air, detergent of any kind will lead to a Customer Induced Damage (CID). CID is not covered under the standard Dell warranty.
- If you notice white powder when you unpack your monitor, wipe it off with a cloth.
- Handle your monitor with care as a darker-colored monitor may get scratched and show white scuff marks more than a lighter-colored monitor.
- To help maintain the best image quality on your monitor, use a dynamically changing screen saver and turn off your monitor when not in use.

Setting up the monitor

Connecting the stand

- ① **NOTE:** The stand is not installed at the factory when shipped.
- ① **NOTE:** The following instructions are applicable only for the stand that was shipped with your monitor. If you are attaching a stand that you purchased from any other source, follow the set up instructions that were included with the stand.

To connect the monitor stand:

1. Open the front flap of the box to get the stand riser and stand base.

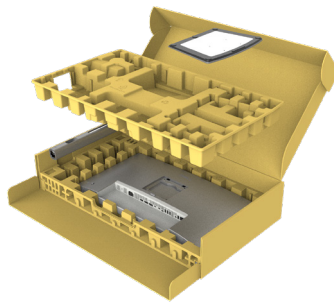

Figure 17. Unboxing

2. Align and place the stand riser on the stand base.
3. Open the screw handle at the bottom of the stand base and turn it clockwise to secure the stand assembly.
4. Close the screw handle.

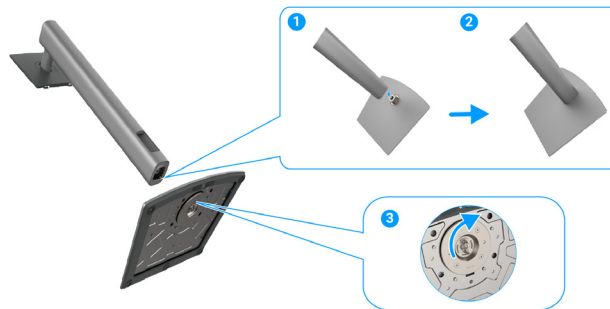

Figure 18. Connecting the stand

5. Open the protective cover on the monitor to access the VESA slot on the monitor.

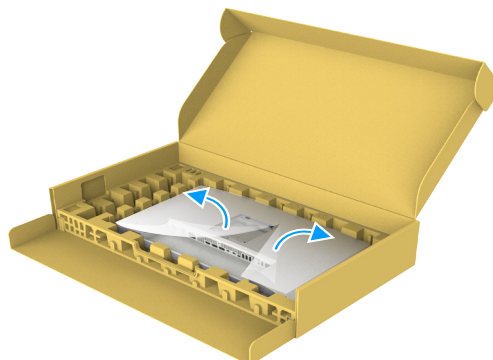

Figure 19. Open the protective cover

6. Carefully insert the tabs on the stand riser into the slots on the display back cover and press the stand assembly down to snap it into place.

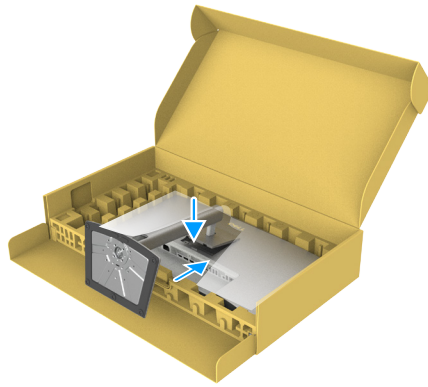

Figure 20. Insert the tabs on the stand riser into the slots

7. Hold the stand riser and lift the monitor carefully, then place it on a flat surface.

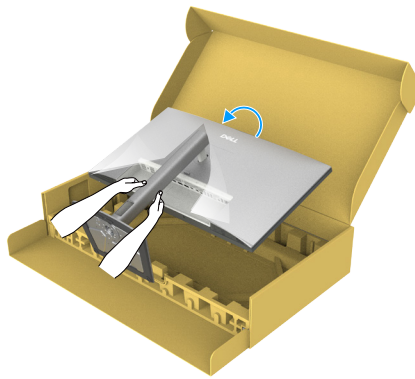

Figure 21. Hold the stand riser and lift the monitor

- ① **NOTE:** Hold the stand riser firmly when lifting the monitor to avoid any accidental damage.
8. Lift the protective cover from the monitor.

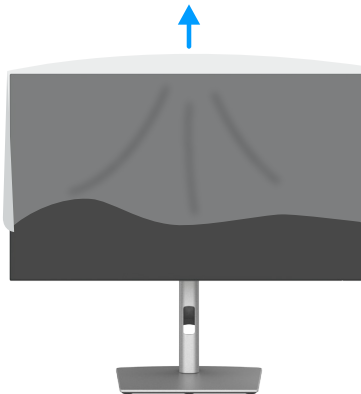

Figure 22. Lift the protective cover from the monitor

Using the tilt, swivel, pivot and height adjustment

NOTE: The following instructions are applicable only for the stand that was shipped with your monitor. If you are attaching a stand that you purchased from any other source, follow the set up instructions that were included with the stand.

Tilt and swivel adjustment

With the stand that is attached to the monitor, you can tilt and swivel the monitor for the most comfortable viewing angle.

U2725QE

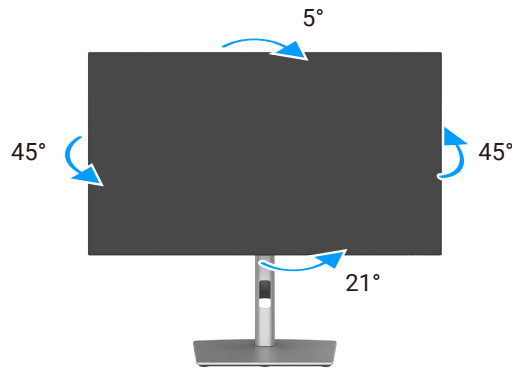

Figure 23. Tilt and swivel adjustment

U3225QE

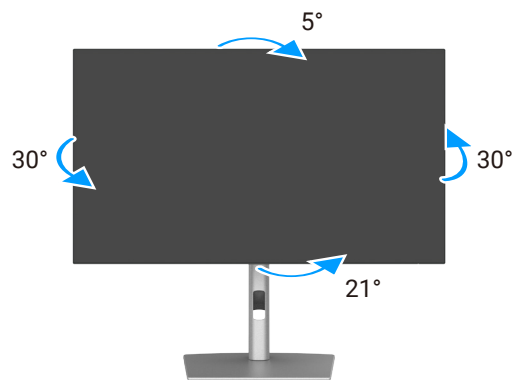

Figure 24. Tilt and swivel adjustment

NOTE: The stand is detached when the monitor is shipped from the factory.

Height adjustment

The stand extends vertically up to 150 mm. The following image illustrates how to extend the stand vertically.

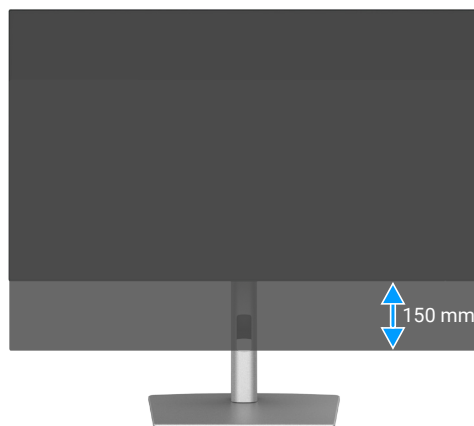

Figure 25. Height adjustment

Pivot adjustment

Before you rotate the display, extend the display vertically until the top of the stand riser and then tilt the display backwards until the maximum to avoid hitting the bottom edge of the display.

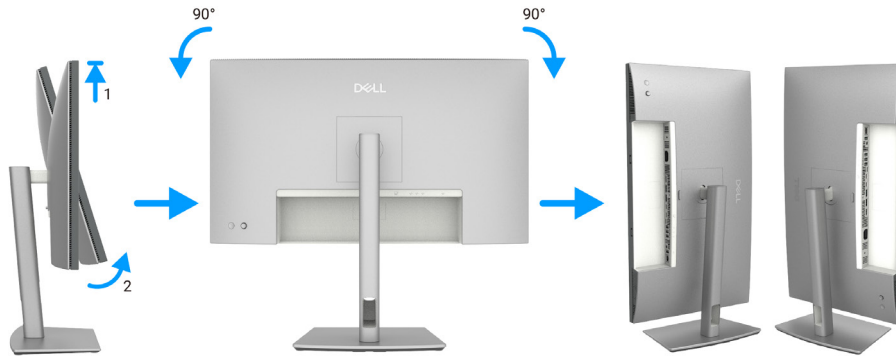

Figure 26. Pivot adjustment

- ① **NOTE:** To toggle the display setting on your Dell computer between landscape and portrait when rotating the display, download and install the latest graphics driver. To download, go to <https://www.dell.com/support/drivers> and search for the appropriate driver.
- ① **NOTE:** When the display is in portrait mode, you may experience performance degradation when using graphic-intensive applications such as 3D gaming.

Adjusting the rotation display settings of your system

After you have rotated your monitor, you need to complete the procedure below to adjust the Rotation Display Settings of your system.

- ① **NOTE:** If you are using the monitor with a non-Dell computer, you need to go the graphics driver website or your computer manufacturer website for information on rotating the 'contents' on your display.

To adjust the Rotation Display Settings:

1. Right-click on the **Desktop** and click **Properties**.
 2. Select the **Settings** tab and click **Advanced**.
 3. If you have an AMD graphics card, select the **Rotation** tab and set the preferred rotation.
 4. If you have an **NVIDIA** graphics card, click the **NVIDIA** tab, in the left-hand column select **NVRotate**, and then select the preferred rotation.
 5. If you have an Intel graphics card, select the Intel graphics tab, click **Graphic Properties**, select the **Rotation** tab, and then set the preferred rotation.
- ① **NOTE:** If you do not see the rotation option or it is not working correctly, go to www.dell.com/support and download the latest driver for your graphics card.

Organizing your cables

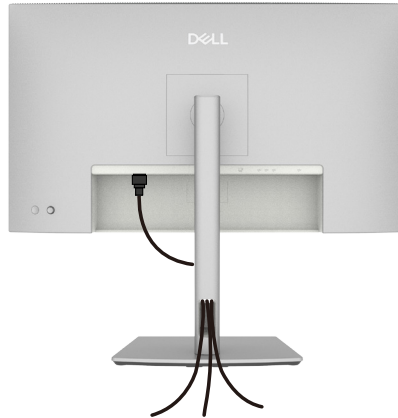

Figure 27. Organizing your cables

When connecting the necessary cables route the cables through the cable-management slot. For more information, see [Connecting your monitor](#).

If your cable is not able to reach your computer, you may connect directly to the computer without routing through the slot on the monitor stand.

Connecting your monitor

- ⚠ **WARNING:** Before you begin any of the procedures in this section, follow the [Safety instructions](#).
- ⚠ **WARNING:** For your safety, be sure that the grounded power outlet you plug the power cord into is easily accessible to operator and located as close to the equipment as possible. To disconnect power from the equipment, unplug the power cord from the power outlet by grasping the plug firmly. Never pull on the cord.
- ℹ **NOTE:** Dell monitors are designed to work optimally with the Dell-supplied cables inside the box. Dell does not guarantee the video quality and performance if non-Dell cables are used.
- ℹ **NOTE:** Route the cables through the cable-management slot before connecting them.
- ℹ **NOTE:** Do not connect all the cables to the computer at the same time.
- ℹ **NOTE:** The images are for the purpose of illustration only. The appearance of the computer may vary.

To connect your monitor to the computer:

1. Turn off your computer and disconnect the power cable.
 2. Connect the HDMI/DisplayPort/Thunderbolt 4 cable from your monitor to the computer.
- ⚠ **CAUTION:** Before using the monitor, it is recommended to fasten the stand riser to a wall using cable tie or a cord that can support the weight of monitor in order to prevent the monitor from falling.

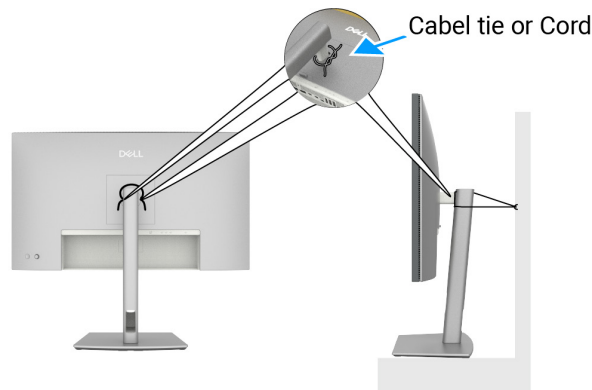

Figure 28. Prevent the monitor from falling

3. Turn on your monitor.
 4. Select the correct input source from the OSD Menu on your monitor and then turn on your computer.
- ℹ **NOTE:** U2725QE/U3225QE default setting is DisplayPort 1.4. A DisplayPort 1.1 Graphic card may not display normally. Please refer to [Product specific problems – No image when using DP connection to the PC](#) to change default setting.
 - ℹ **NOTE:** Remove the rubber plug when using DisplayPort (out) or Thunderbolt 4 downstream or USB-C upstream connector.

Connecting the HDMI cable (Optional)

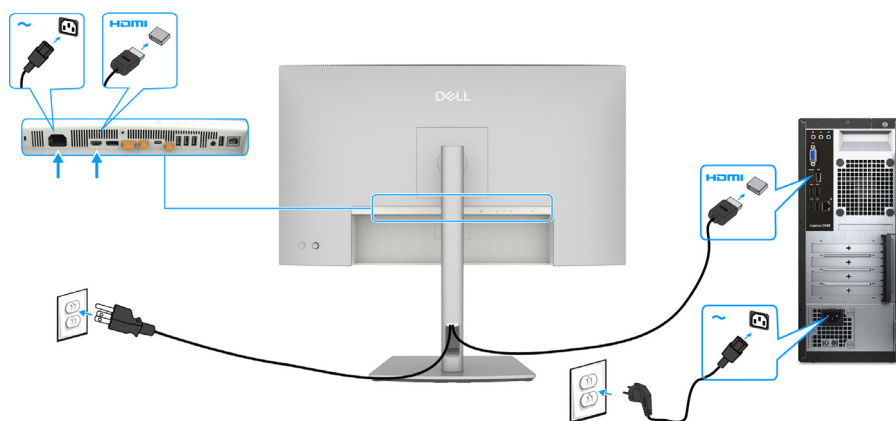

Figure 29. Connecting the HDMI cable

Connecting the DisplayPort cable

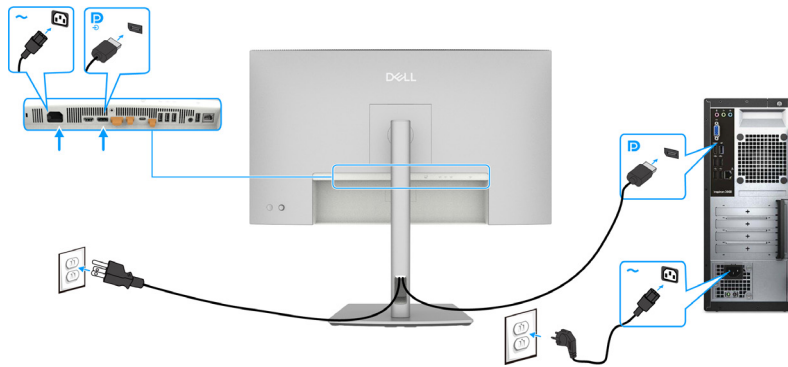

Figure 30. Connecting the DisplayPort cable

Connecting the monitor for DP Multi-Stream Transport (MST) function

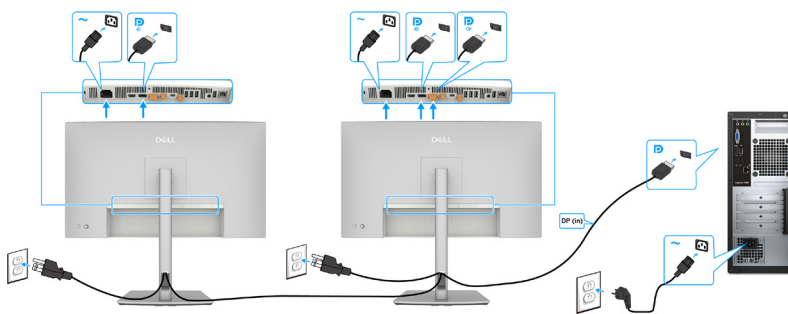

Figure 31. Connecting the monitor for DP Multi-Stream Transport (MST) function

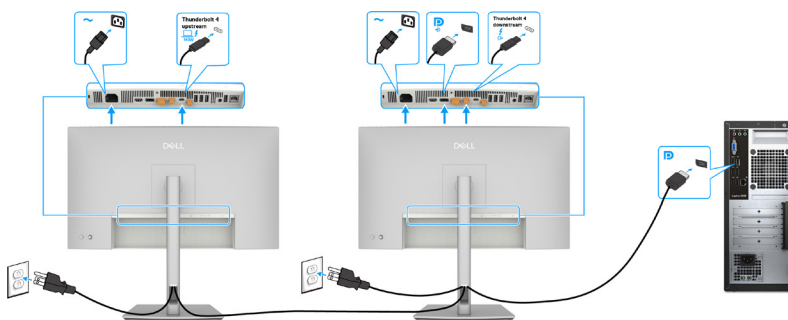

Figure 32. Connecting the monitor for DP-TBT Multi-Stream Transport (MST) function

NOTE: Supports the DisplayPort MST feature. To make use of this feature, your computer graphics card must be certified to at least DisplayPort 1.2 with MST option.

Connecting the Thunderbolt 4 cable

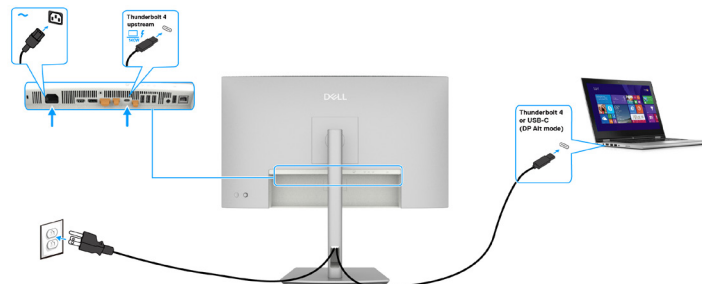

Figure 33. Connecting the Thunderbolt 4 cable

Connecting the Monitor for Thunderbolt 4 daisy chain function

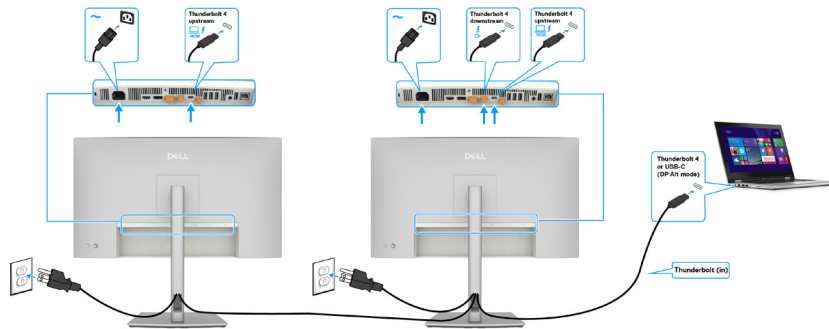

Figure 34. Connecting the Monitor for Thunderbolt 4 daisy chain function-1

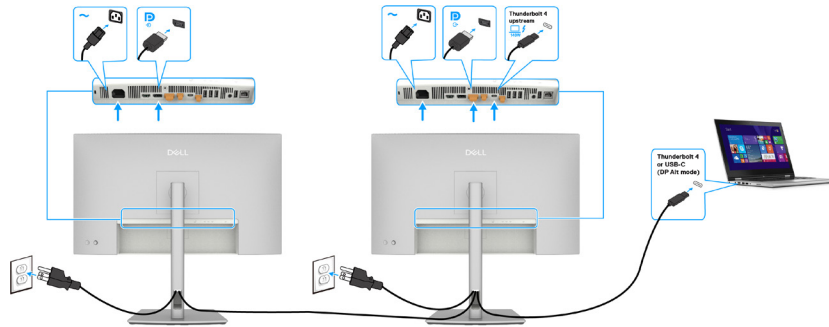

Figure 35. Connecting the Monitor for TBT-DP daisy chain function

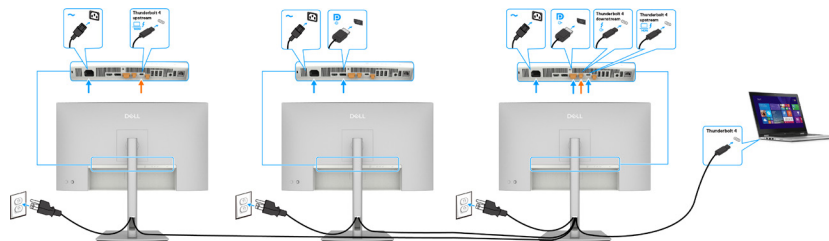

Figure 36. Connecting the Monitor for TBT-DP daisy chain function-2

- NOTE:** The maximum number of supported monitors through via MST is subjected to the bandwidth of the Thunderbolt 4. Please refer to [Product specific problems - No image when using Thunderbolt 4 daisy chain](#). DP and USB-C (DP alt mode) source MST must be enabled with primary monitor OSD to project display on the secondary monitor.
- WARNING:** The Dell UltraSharp U2725QE/U3225QE supports the USB-C Power Delivery 3.1 (Thunderbolt 4) specification and can provide a maximum output of up to 140 W. For safety consideration, this USB-C port must be connected to the Dell-approved products with the inbox Thunderbolt 4 Passive cable. For the list of Dell-approved products, refer Dell products compatible with USB-C Power Delivery 3.1 (Extended Power Range 140 W) Tech sheet at Dell.com/support/U2725QE, Dell.com/support/U3225QE.

Connecting the USB-C cable (A to C)

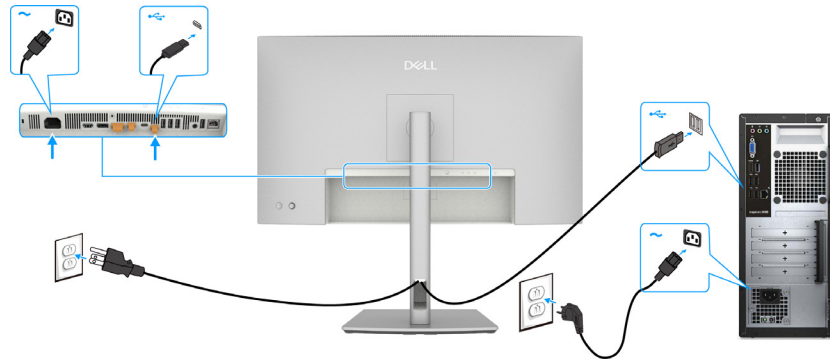

Figure 37. Connecting the USB-C cable (A to C)

NOTE: This connection supports data only and does not transmit video. An additional video connection for display is needed.

Connecting the monitor for RJ45 cable, LAN access via monitor network port (optional)

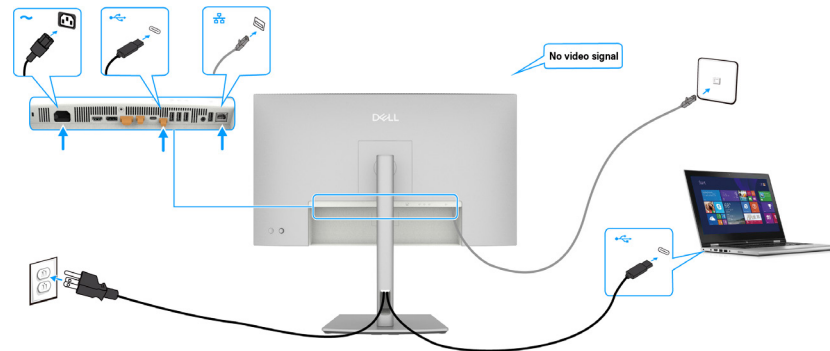

Figure 38. Network routing via USB-C upstream port

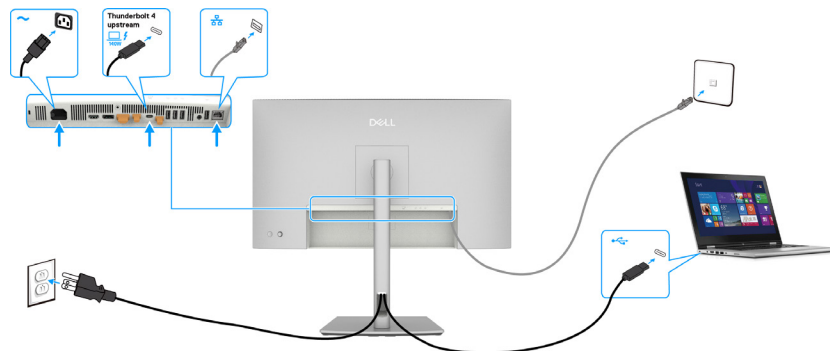

Figure 39. Network routing via Thunderbolt 4 upstream port

Dell Power Button Sync (DPBS)

The monitor is designed with Dell Power Button Sync (DPBS) feature to allow you to control computer power state from the monitor power button. This feature is only supported with Dell platform which has built-in DPBS function, and is only supported over Thunderbolt 4 interface.

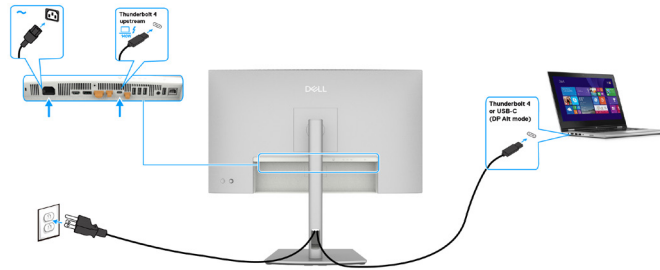



Figure 40. Connecting the Thunderbolt 4 cable

To make sure the DPBS function works for the first time, perform the following steps on the DPBS supported platform in the **Control Panel** first.

NOTE: DPBS only supports the port with  icon.

1. Go to **Control Panel**.

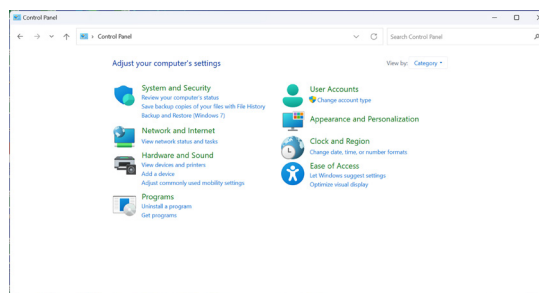

Figure 41. Dell Power Button Sync-Control Panel

2. Select **Hardware and Sound**, followed by **Power Options**.

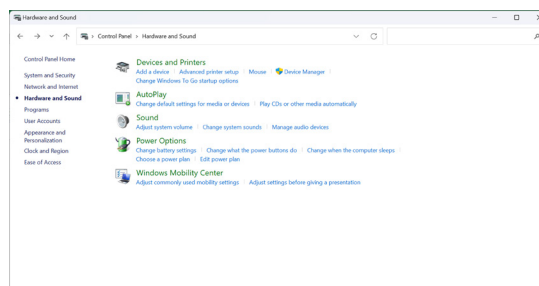

Figure 42. Dell Power Button Sync-Hardware and Sound

3. Go to **System Settings**.

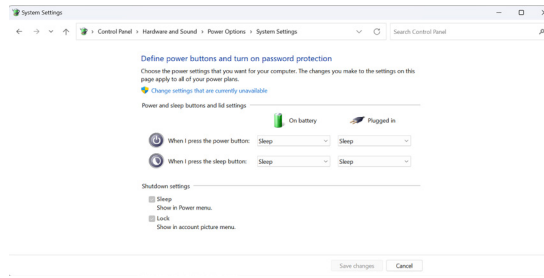

Figure 43. Dell Power Button Sync-system settings

4. Select the preferred options from **When I press the power button**.

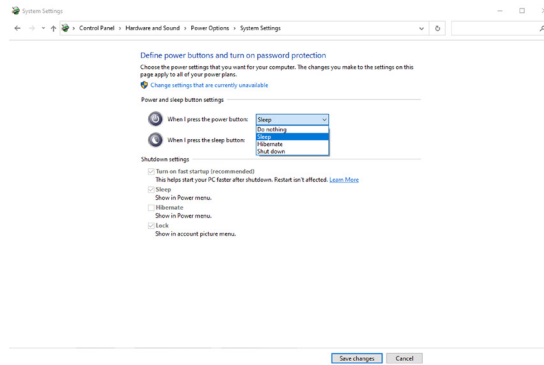

Figure 44. Dell Power Button Sync-Power button settings

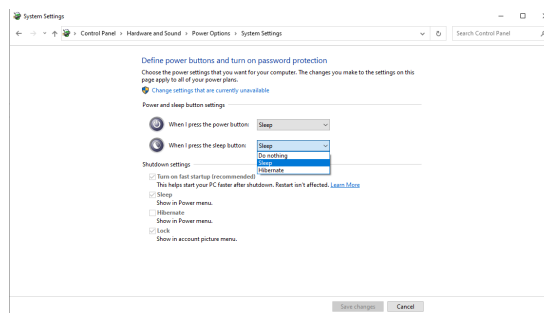

Figure 45. Dell Power Button Sync-Sleep button settings

NOTE: Do not select **Do nothing**, otherwise monitor power button cannot sync with computer power state.

Connecting the monitor for DPBS for the first time

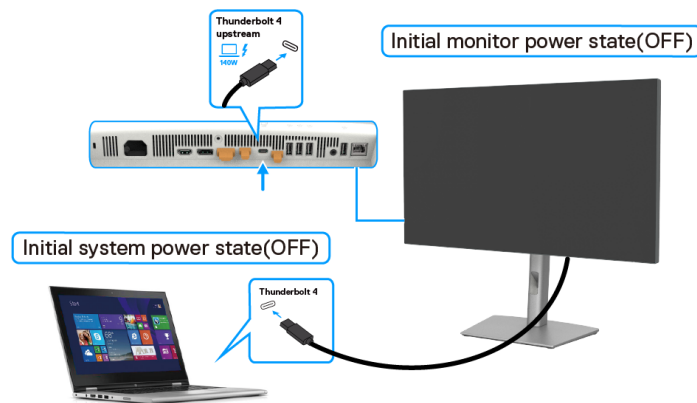

Figure 46. Dell Power Button Sync-Connecting for the first time

Perform the following steps when setting up the DPBS function for the first time:

1. Navigate to **Dell Power Button Sync** in sub menu under **Display** and enable it.
2. Ensure both the computer and the monitor are turned **OFF**.
3. Connect the Thunderbolt 4 cable from the computer to the monitor.
4. Press the monitor power button to turn ON the monitor.
5. Both the monitor and computer will turn ON momentarily. If not, press either the monitor power button or computer power button to boot up the system.
6. When you connect the Dell OptiPlex 7090/3090 Ultra platform, you may see both the monitor and computer will turn ON momentarily. Wait for a while (approximately 6 seconds) and both the PC and monitor will turn OFF. When you press either the monitor power button or computer power button, both the computer and monitor will turn ON. The computer system power state is in sync with the monitor power button.

i NOTE: When the monitor and computer are both at power OFF state at first time, it is recommended that you turn ON the monitor first, then connect the Thunderbolt 4 cable from the computer to the monitor.

i NOTE: You can power the Dell PC* Ultra platform using its DC adaptor jack. Alternatively, you can power the Dell computer* Ultra platform using the monitor's Thunderbolt 4 cable via Power Delivery (PD); please set Thunderbolt 4 Charging to On in Off Mode.

* Ensure to check the Dell computer for DPBS supportability.

Using DPBS function

When you connect the Thunderbolt 4 cable, the monitor/computer state is as follows:

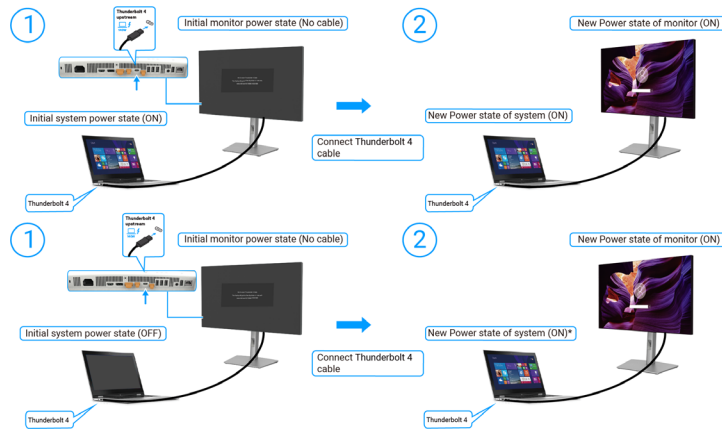

Figure 47. Dell Power Button Sync-Connect the Thunderbolt 4 cable

*Not all Dell computers support to wake up the platform through the monitor.

*Upon USB-C cable connection, mouse movement or keyboard press might be required to wake the computer/monitor up from sleep or hibernate.

When you press the monitor power button or computer power button, the monitor/computer state is as follows:

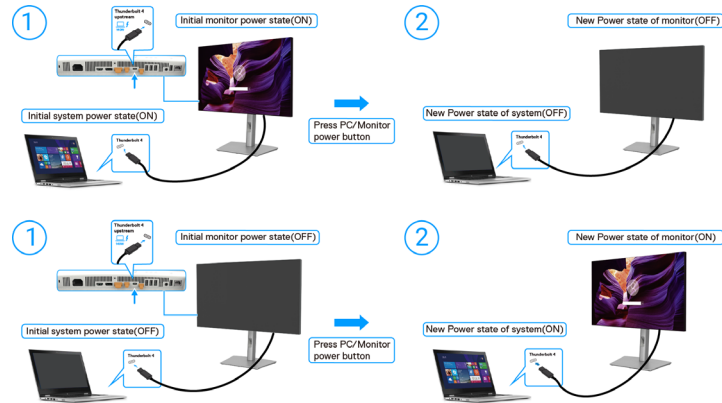

Figure 48. The state of the monitor/computer

NOTE: You can enable or disable the power button sync function using the OSD. See [Dell Power Button Sync](#).

When the monitor and computer power state are both ON, while you **press and hold 4 seconds on monitor power button**, the screen prompt will ask if you would like to shut down the computer.

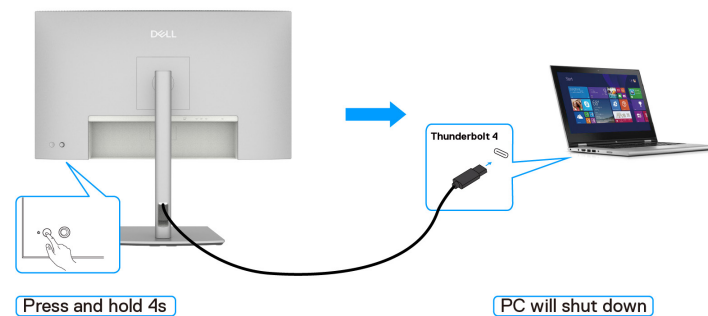

Figure 49. Press and hold 4 seconds on monitor power button

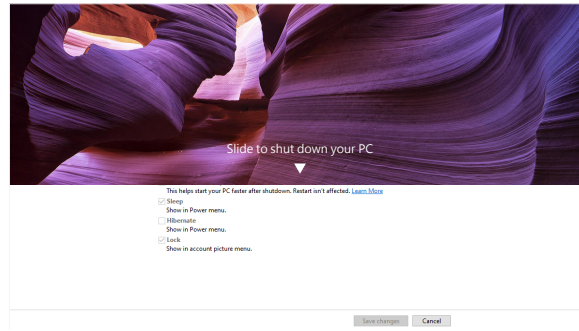

Figure 50. Slide to shut down your computer

When the monitor and computer power state are both ON, while **you press and hold 10 seconds on monitor power button**, the computer will shut down.

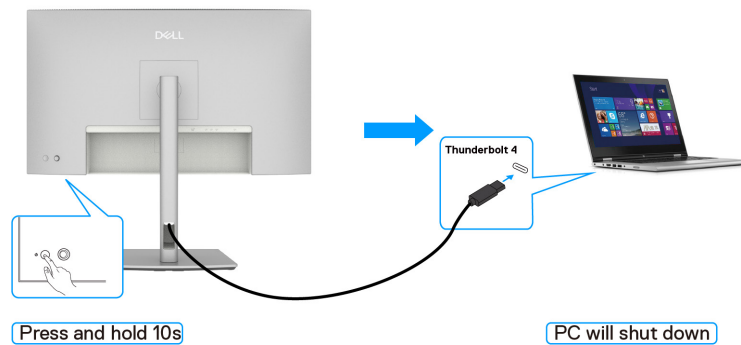

Figure 51. Press and hold 10 seconds on monitor power button

Connecting the monitor for Thunderbolt 4 daisy chain function

A computer is connected to two monitors in an initially OFF power state, and the computer power state is in sync with Monitor 1 power button. When you press the Monitor 1 or computer power button, both Monitor 1 and computer turns ON. Meanwhile the Monitor 2 will remain OFF. You need to manually press the power button on Monitor 2 to turn it ON.

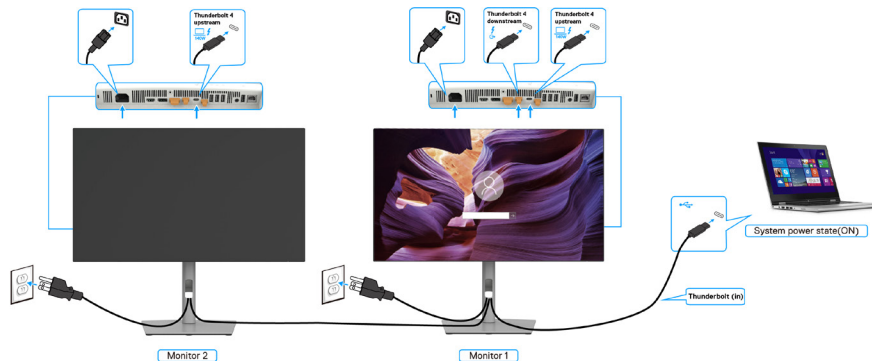

Figure 52. Connecting the monitor for Thunderbolt 4 daisy chain function-on

Similarly, a computer is connected to two monitors in an initially ON power state, and the computer power state is in sync with Monitor 1 power button. When you press the Monitor 1 or computer power button, both the Monitor 1 and computer turns OFF. Meanwhile the Monitor 2 will be in Standby mode. You need to manually press the power button on Monitor 2 to turn it OFF.

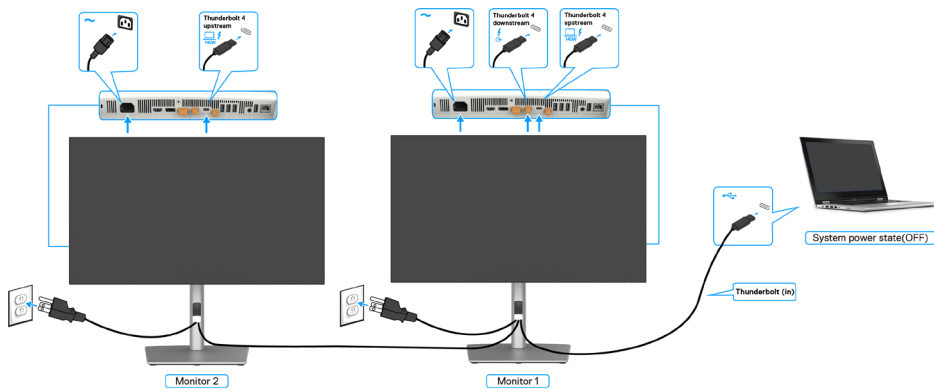



Figure 53. Connecting the monitor for Thunderbolt 4 daisy chain function-OFF

Connect multiple Thunderbolt 4 monitors to one system

The Dell computer* Ultra platform has two Thunderbolt 4 ports, so both Monitor 1 and Monitor 2 power state can sync with the computer.

While the computer and two monitors are in an initially ON power state, by pressing the power button on Monitor 1 or Monitor 2 will turn OFF the computer, Monitor 1, and Monitor 2.

* Ensure to check the Dell computer for DPBS supportability.

NOTE: DPBS only supports the port with  icon.

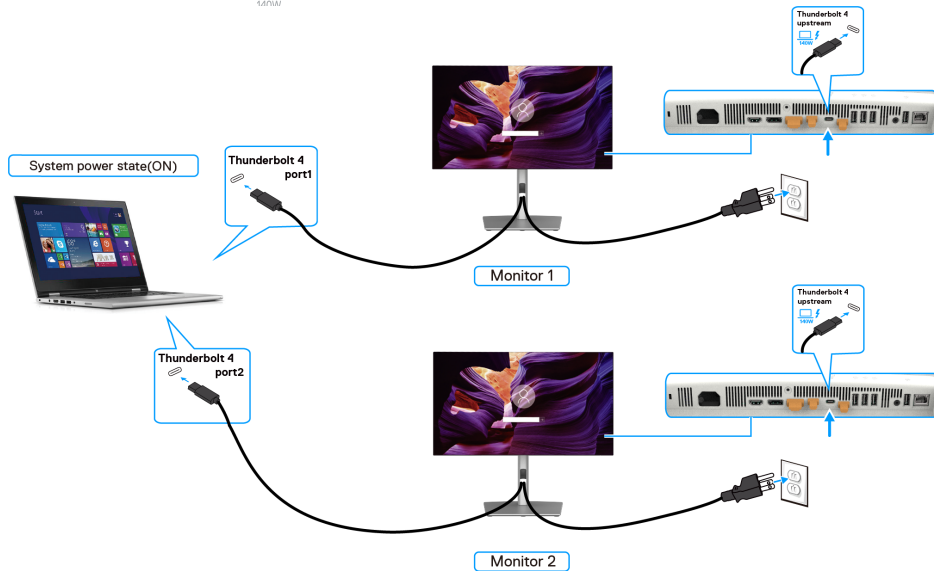

Figure 54. Two monitors power state can sync with the computer in DPBS mode

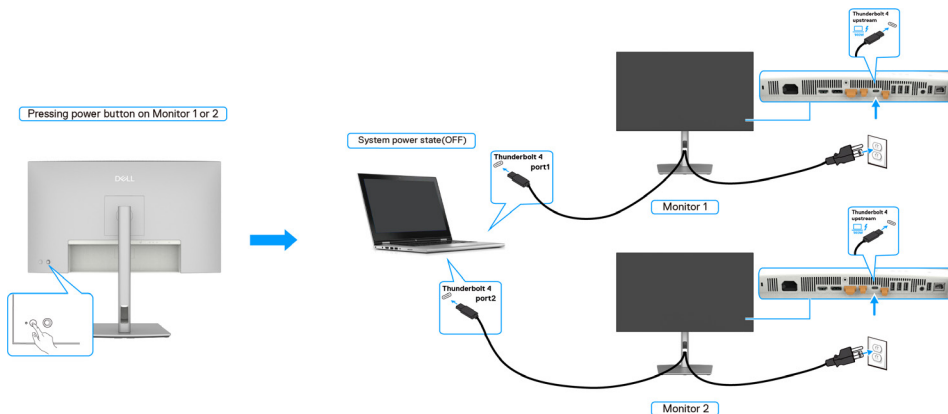

Figure 55. Pressing the power button on either monitor will turn off both monitors and the computer

Make sure to set **Thunderbolt 4** to On in Off Mode. While the computer and two monitors are in an initially OFF power state, by pressing the power button on Monitor 1 or Monitor 2 will turn ON the computer, Monitor 1, and Monitor 2.

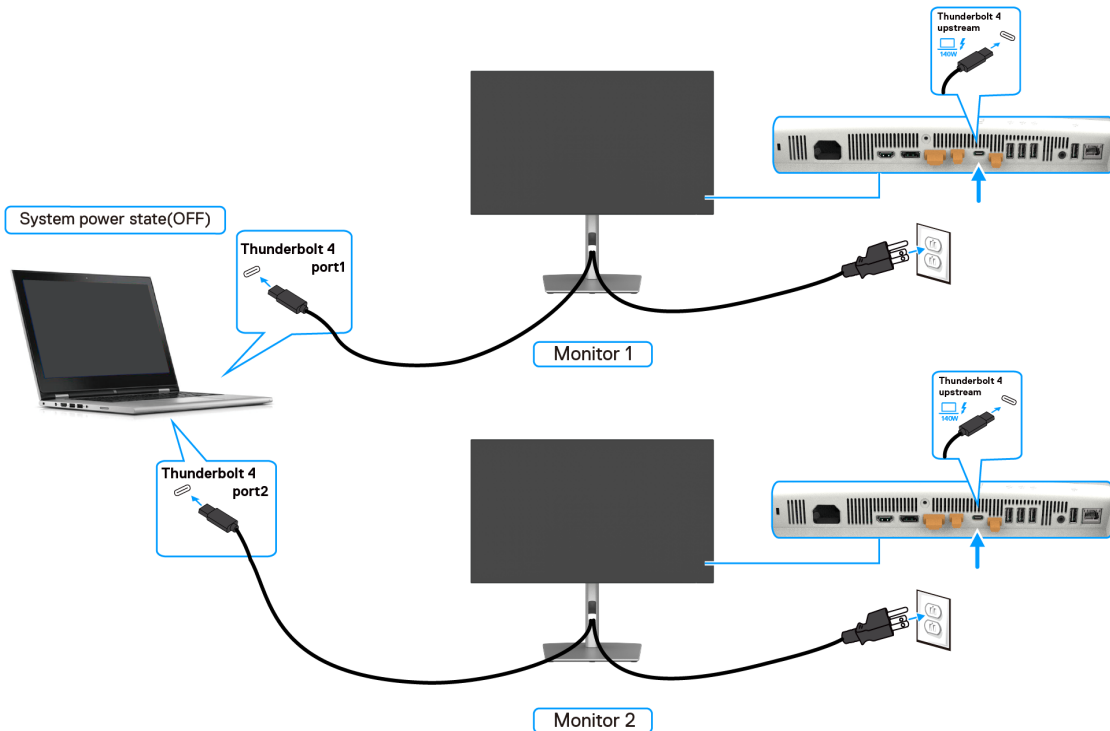

Figure 56. Two monitors and computer power state Off in DPBS mode

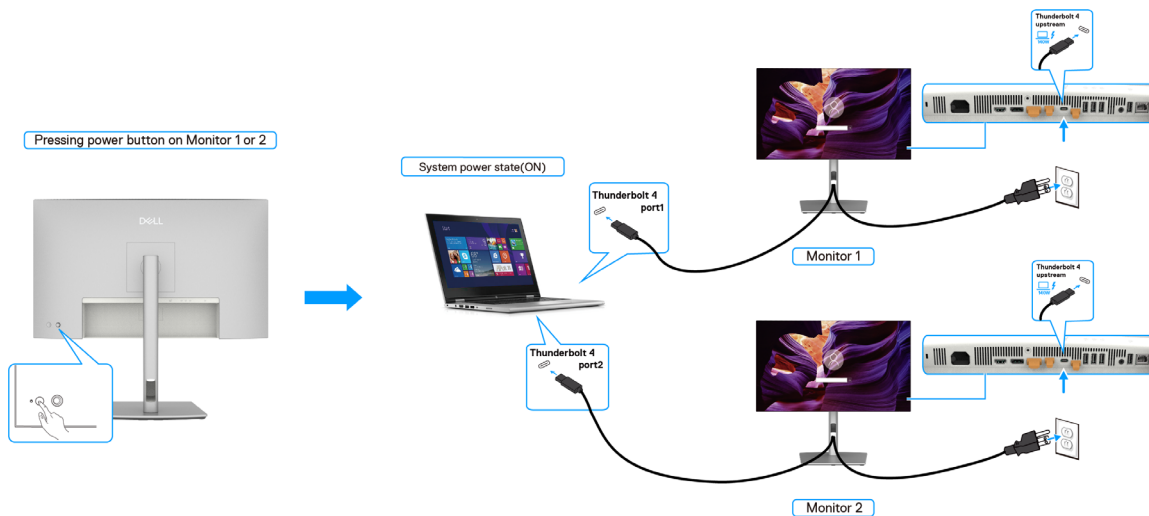

Figure 57. Two monitors and computer power state On in DPBS mode

Securing your monitor using Kensington lock (optional)

The security-lock slot is located at the bottom of the monitor (see [Security lock slot](#)). Secure your monitor to a table using the Kensington security lock.

For more information on using the Kensington lock (sold separately), see the documentation that is shipped with the lock.

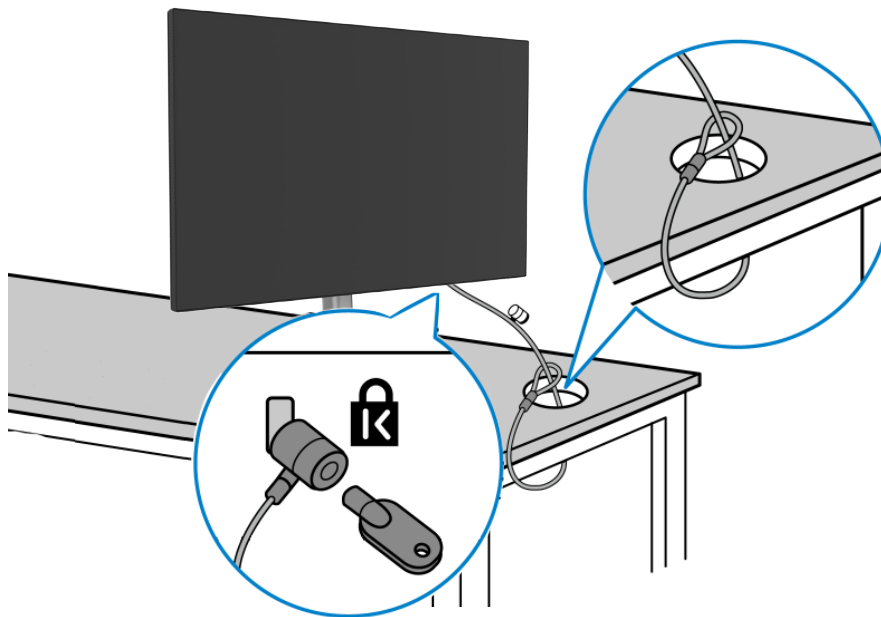

Figure 58. Kensington_Noble lock

NOTE: The image is for the purpose of illustration only. The appearance of the lock may vary.

Removing the monitor stand

CAUTION: To prevent scratches on the LCD screen when removing the stand, ensure that the monitor is placed on a soft surface and handle it carefully.

NOTE: The following steps are specifically for removing the stand that is shipped with your monitor. If you are removing a stand that you purchased from any other source, follow the setup instructions that are included with the stand.

To remove the stand:

1. Place the monitor on a soft cloth or cushion.
2. Press and hold the stand-release button.
3. Lift the stand up and away from the monitor.

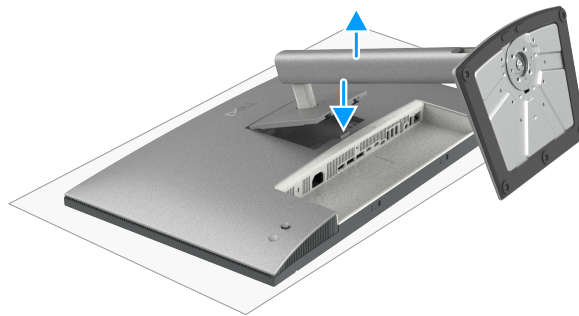

Figure 59. Remove stand

VESA wall mounting (optional)

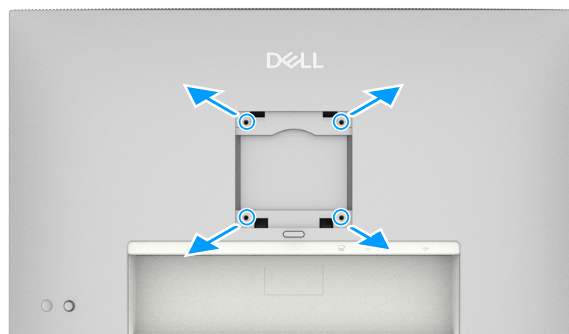

Figure 60. Wall Mounting

NOTE: Use M4x10 mm screws to connect the monitor to the wall-mounting kit.

Refer to the instructions that come with the VESA-compatible wall mounting kit.

1. Place the monitor on a soft cloth or cushion on a stable flat table.
2. Remove the stand (See [Removing the monitor stand](#)).
3. Use a Phillips crosshead screwdriver to remove the four screws securing the plastic cover.
4. Attach the mounting bracket from the wall-mounting kit to the monitor.
5. Mount the monitor on the wall. For more information, see the documentation that is shipped with the wall-mounting kit.

NOTE: For use only with UL or CSA or GS-listed wall mount bracket with minimum weight or load bearing capacity of 20.88 kg (46.03 lb) (U2725QE) / 26.08 kg (57.50 lb) (U3225QE).

Operating the monitor

Turn on the monitor

Press the power button to turn on the monitor.

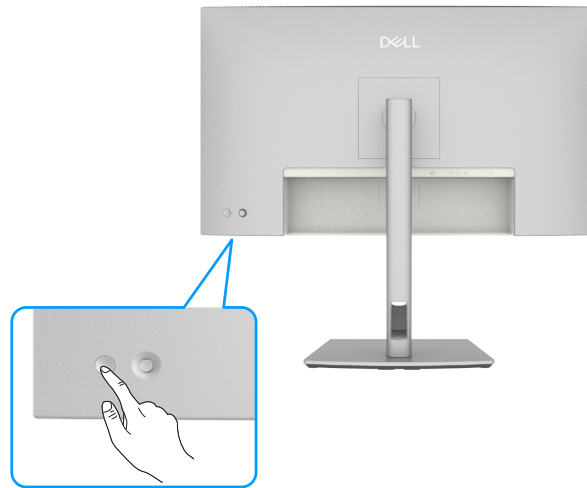

Figure 61. Power on the monitor

Using the joystick control

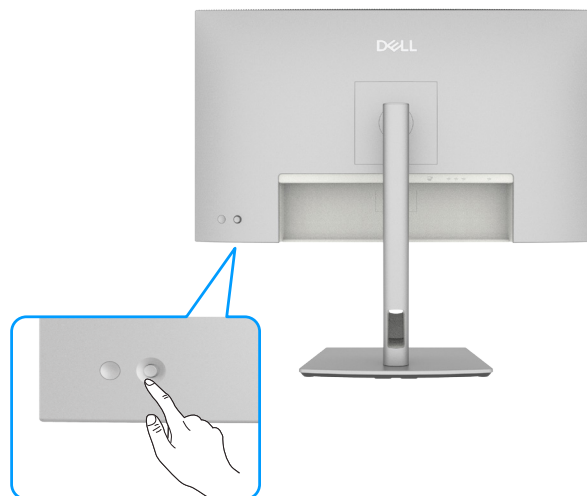





Figure 62. Using the joystick control

To modify the OSD adjustments using the joystick control on the rear end of the monitor, do the following:

1. Press the joystick to open the OSD Menu Launcher.
2. Move the joystick up/down/left/right to toggle between the OSD menu options.

Joystick functions

Table 34. Joystick functions.

Function	Description
	Press Joystick to open the OSD Menu Launcher.
	For right and left navigation.
	For up and down navigation.

Using the Menu Launcher

Press the Joystick to open the OSD Menu Launcher.

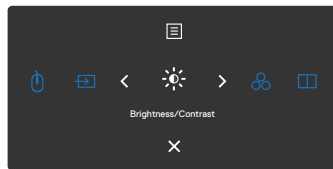









Figure 63. Menu Launcher

- Toggle the Joystick **Up** to open the **Main Menu**.
- Toggle the Joystick **Left** or **Right** to select the desired **Shortcut Keys**.
- Toggle the Joystick **Down** to **Exit**.

Menu Launcher details

The following table describes the Menu Launcher icons:

Table 35. Menu Launcher description.

Menu Launcher icon	Description
 Main Menu	Opens the On-Screen Display (OSD). See Using the main menu .
 USB Switch (Shortcut key 1)	In PBP/PIP mode, you can switch USB between the main and secondary screens.
 Input Source (Shortcut key 2)	Sets the Input Source .
 Brightness/Contrast (Shortcut key 3)	To directly access the Brightness/Contrast adjustment sliders.
 Preset Modes (Shortcut key 4)	Allows to choose from a list of Preset color modes .
 PIP/PBP Mode (Shortcut key 5)	Use this button to choose from a list of PIP/PBP .
 Exit	Exits from the OSD main menu.

Using the navigation keys

When the OSD main menu is active, move the joystick to configure the settings, following the navigation keys displayed below the OSD.

NOTE: To exit the current menu item and return to the previous menu, move the joystick to the left until you exit.

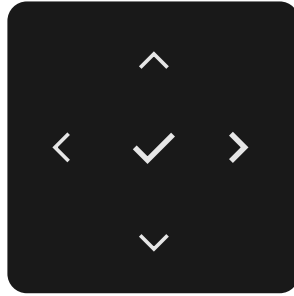







Figure 64. Navigation keys

Table 36. Navigation keys description.

Front panel	Description
1  Up  Down	Use the Up (increase) and Down (decrease) navigation keys to adjust items in the OSD menu.
2  Left	Use the Left navigation key to go back to the previous menu.
3  Right	Use the Right navigation key to confirm your selection.
4  OK	Press the joystick to confirm your selection.

Using the Main Menu

Table 37. Main Menu description.

Icon	Menu and Submenus	Description
	Brightness/Contrast	Adjust the Brightness , Contrast , Auto Brightness , Auto Brightness Range Level , Auto Color Temp. , Primary Monitor for Sync and Reset Brightness/ Contrast functions.
	Brightness	Adjusts the luminance of the backlight (Range: 0 - 100). Move the Joystick Up to increase brightness. Move the Joystick Down to decrease brightness.
	Contrast	Adjust the Brightness first, and then adjust Contrast only if further adjustment is necessary. Move the Joystick Up to increase contrast and Move the Joystick Down to decrease contrast (Range: 0 - 100). The Contrast function adjusts the degree of difference between darkness and lightness on the monitor screen.
	Auto Brightness	Turns on the Auto Brightness and adjusts the monitor brightness setting according to the ambient light.
	Auto Brightness Range Level	When Auto Brightness is turned on, adjust the range level of the Auto Brightness. NOTE: When Auto Brightness is turned off, this function is not available.
	Auto Color Temp.	Turns on Auto Color Temp and adjusts the monitor RGB color settings in accordance with the ambient light.
	Primary Monitor for Sync	When either Auto Brightness or Auto Color Temp. is turned on and multiple Dell monitors that support this function are connected through MST , the monitors will adjust their brightness or RGB settings according to the ambient light condition detected by the primary monitor. NOTE: The selected monitor in Dell Display and Peripheral Manager (DDPM) is the primary monitor. To change the primary monitor, select the preferred monitor in DDPM. Refer to the DDPM user guide for details. NOTE: When Auto Brightness and Auto Color Temp. are both turned off, this function is not available. NOTE: If the primary or secondary monitor breaks off from the MST, it also breaks off from the monitor sync.
	Reset Brightness/ Contrast	Resets all settings under the Brightness/ Contrast menu to the factory defaults.

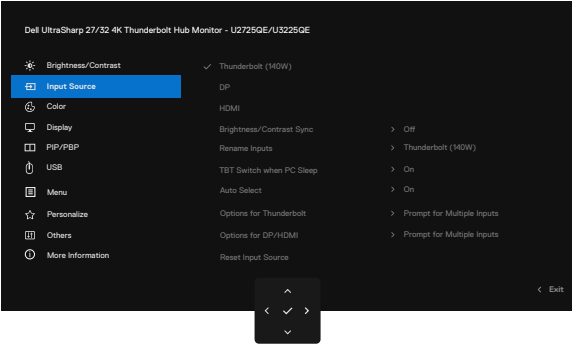

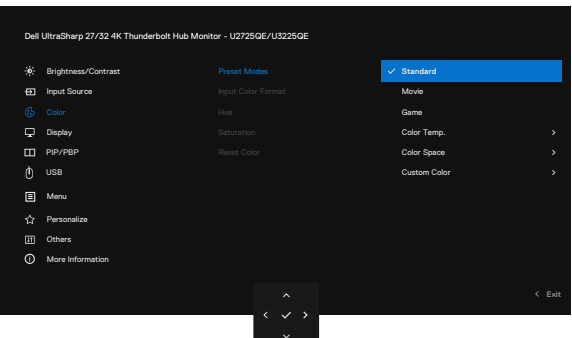
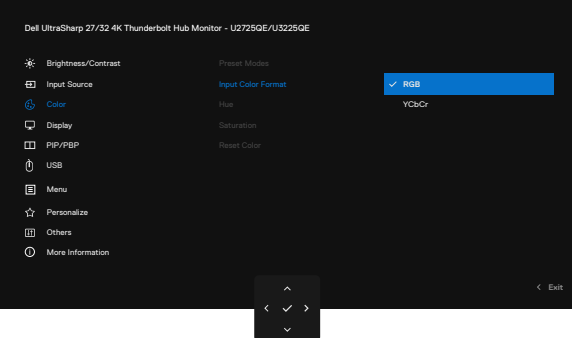
Icon	Menu and Submenus	Description
	Input Source	Selects between different video inputs that are connected to your monitor. 
	Thunderbolt (140 W)	Select Thunderbolt (140W) input when you are using the Thunderbolt (140 W) connector. Press the joystick button to confirm the selection.
	DP	Select DP input when you are using the DP (DisplayPort) connector. Press the Joystick button to confirm the selection.
	HDMI	Select the HDMI input when you are using the HDMI connector. Press the Joystick button to confirm the selection.
	Brightness/Contrast Sync	Select ON to apply unified Brightness and Contrast level to all input sources. Select OFF to have independent Brightness and Contrast settings.
	Rename Inputs	Allows you to Rename Inputs .
	TBT Switch when PC Sleep	Select ON: When TBT PC enter Sleep mode, it allows Monitor switching to another input sources. Select OFF: When TBT PC enter Sleep mode, it keeps the Monitor connection until TBT cable is unplugged.
	Auto Select	Allows you to scan for available input sources. Press the joystick to select this function.
	Option for Thunderbolt	Press the joystick to select these functions: <ul style="list-style-type: none"> • Prompt for Multiple Inputs: Always show Switch to Thunderbolt Video Input message for user to choose whether to switch or not. • Always Switch: The monitor always switches to Thunderbolt video by default while Thunderbolt is connected. • Off: The monitor does not auto-switch to Thunderbolt video from another available input.
	Option for DP/HDMI	Press the joystick to select these functions: <ul style="list-style-type: none"> • Prompt for Multiple Inputs: Always show Switch to DP/HDMI Video Input message for user to choose whether to switch or not. • Always Switch: The monitor always switches to DP/HDMI video by default while DP/HDMI is connected. • Off: The monitor does not auto-switch to DP/HDMI video from another available input.
	Reset Input Source	Resets all settings under the Input Source menu to the factory defaults. Press the joystick to select this function.

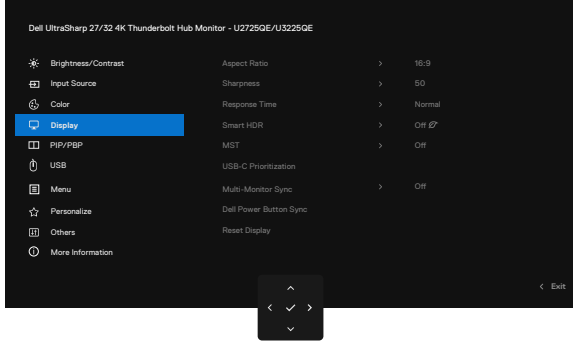
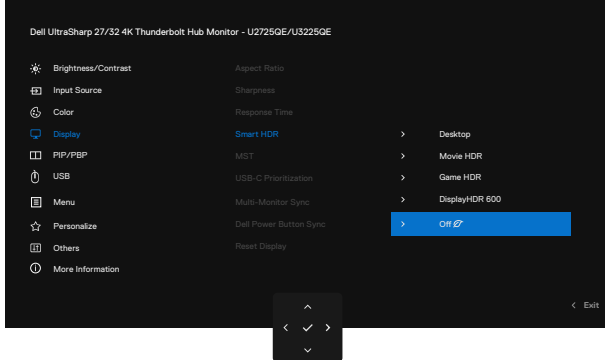

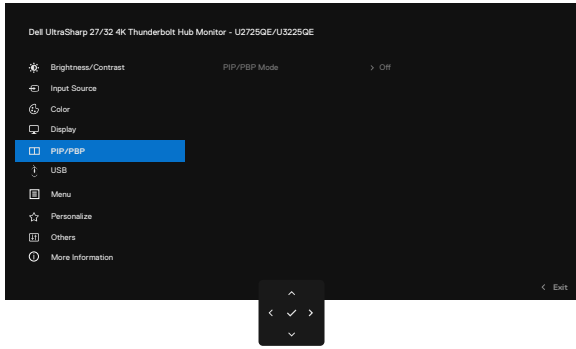

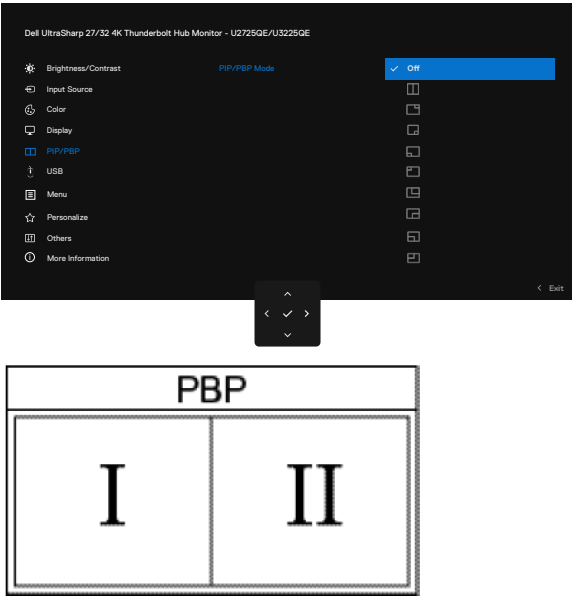
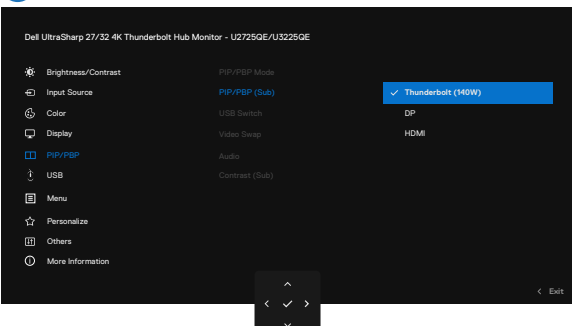

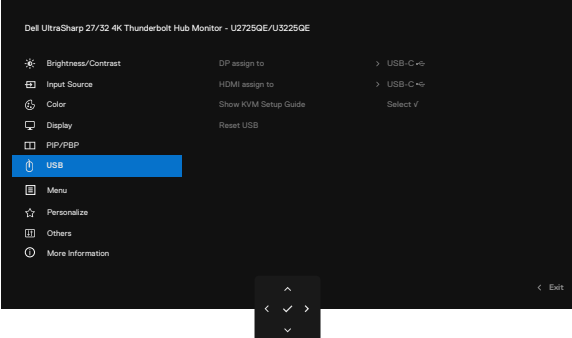
Icon	Menu and Submenus	Description
	Color	<p>Adjusts the color setting mode.</p> 
	Preset Modes	<p>When you select Preset Modes, you can choose Standard, Movie, Game, Color Temp., Color Space or Custom Color from the list.</p>  <ul style="list-style-type: none"> • Standard: Default Color setting, this monitor uses a low blue light panel, and is certified by TUV to reduce blue light output and create a more relaxing and less stimulating image while reading content on the screen. • Movie: Ideal for movies. • Game: Ideal for most gaming applications. • Color Temp.: The screen appears warmer with a red/yellow tint with slider set at 5,000K or cooler with blue tint with slider set at 10,000K. • Color Space: Allows users to select the color space: sRGB, BT.709, DCI-P3, Display P3. • Custom Color: Allows you to manually adjust the color settings. Press the Joystick left and right buttons to adjust the Red, Green, and Blue values and create your own preset color mode.
	Input Color Format	<p>Allows you to set the video input mode to:</p> <ul style="list-style-type: none"> • RGB: Select this option if your monitor is connected to a computer or a media player that supports RGB output. • YCbCr: Select this option if your media player supports only YCbCr output. 
	Hue	<p>Use Joystick Up or Down to adjust the Hue from 0 to 100.</p> <p> NOTE: Hue adjustment is available only for Movie and Game mode.</p>

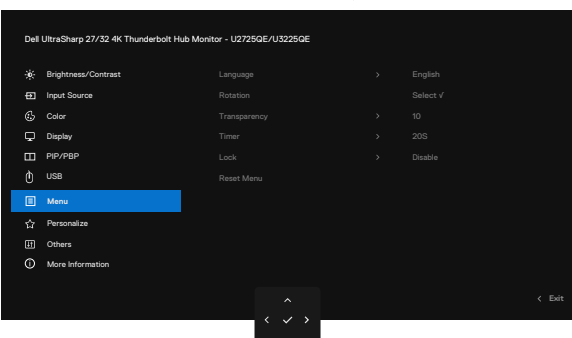
Icon	Menu and Submenus	Description
	Saturation	Use Joystick Up or Down to adjust the Saturation from 0 to 100. NOTE: Saturation adjustment is available only for Movie and Game mode.
	Reset Color	Resets your monitor's color settings to the factory defaults. Press the joystick to select this function.
	Display	Use the Display menu to adjust image. 
	Aspect Ratio	Adjust the image ratio to 16:9, Auto Resize, 4:3, 1:1 .
	Sharpness	Makes the image look sharper or softer. Move the Joystick up and down to adjust the sharpness from '0' to '100'.
	Response Time	Allows you to set the Response Time to Normal or Fast .
	Smart HDR	 <p>Press the joystick to select these functions.</p> <p>Smart HDR (High Dynamic Range) automatically enhances the display output by adjusting the settings optimally to resemble life-like visuals.</p> <p>Desktop: This is the default mode. This mode is more suitable for general usage of the monitor with a desktop computer.</p> <p>Movie HDR: Use this mode during playback of HDR video content to expand the contrast ratio, brightness, and color palette. It matches the video quality with real life visuals.</p> <p>Game HDR: Use this mode when playing games that support HDR to expand the contrast ratio, brightness, and color palette. It makes the gaming experience more realistic as intended by game developers.</p> <p>DisplayHDR 600: Best used with content that complies with DisplayHDR standards.</p> <p>Off: Disables Smart HDR function.</p> <p>NOTE: The possible peak luminance during HDR mode is 600-nits (typical). The actual value and duration during HDR playback might vary accordingly to the video content.</p> <p>NOTE: HDR option on both the Monitor and Computer must be enabled to activate HDR display content.</p> <p>Auto Brightness and Auto Color Temp. are disabled when Smart HDR is enabled.</p>

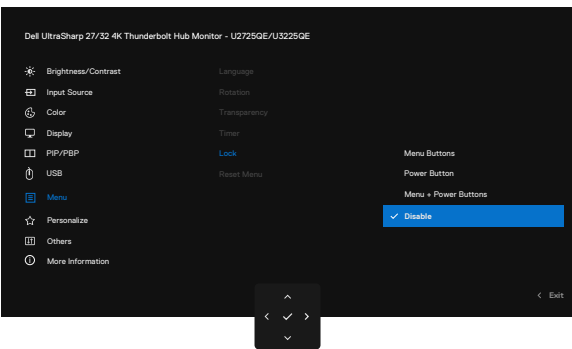
Icon	Menu and Submenus	Description																			
	MST	<p>DP Multi Stream Transport, if connect DP source or USB-C(DP alt mode) source,Set to ON enables monitor daisy chain via DP out port or TBT out port.</p> <p>If connect TBT source or USB 4 source, whether MST set on or off, TBT out port is always enabled for monitor daisy chain. if MST set off, the TBT output port have more bandwidth to switch resolution and refresh rate.</p> <p>i NOTE: If source is DP source or USB-C(DP alt mode) source, when DP/TBT upstream cable and DP/TBT downstream cable is connected, monitor will set MST = ON automatically, this action will only be done once after Factory Reset or Display Reset. Please refer to Connecting the monitor for DP Multi-Stream Transport (MST) function.If source is TBT source or USB 4 source, when TBT upstream cable and TBT downstream cable is connected, monitor will not set MST = ON.</p>																			
	USB-C Prioritization	<p>Allows you to specify the priority to transfer the data with high resolution (High Resolution) or high speed (High Data Speed) when using the TBT port (DP ALT mode).</p> <p>i NOTE: If you are connecting to a Thunderbolt video signal source, this option is disabled. This option is only enabled if you are connecting to a USB-C video signal source.</p>																			
	Multi-Monitor Sync	<p>Multi-Monitor Sync allows multiple monitors that are daisy chained via DisplayPort to synchronize a pre-defined group of OSD settings in the background.</p> <p>An OSD option, "Multi-Monitor Sync" will be created in Display Menu to allow user to enable/disable syncing.</p>																			
	Dell Power Button Sync	<p>To allow you to control PC system power state from the monitor power button.</p> <p>Allows you to On or Off Dell Power Button Sync function.</p> <p>i NOTE: This feature is only supported with Dell platform which has built-in DPBS function, and is only supported over Thunderbolt interface.</p>																			
	Reset Display	<p>Resets all settings under the Display menu to the factory defaults.</p> <p>Press the joystick to select this function.</p>																			
	PIP/PBP	<p>This function brings up a window displaying image from another input source.</p>  <table border="1" data-bbox="395 1429 1061 1624"> <thead> <tr> <th rowspan="2">Main Window</th> <th colspan="3">Sub-Window</th> </tr> <tr> <th>Thunderbolt 4</th> <th>HDMI</th> <th>DP</th> </tr> </thead> <tbody> <tr> <td>Thunderbolt 4</td> <td>X</td> <td>√</td> <td>√</td> </tr> <tr> <td>HDMI</td> <td>√</td> <td>X</td> <td>√</td> </tr> <tr> <td>DP</td> <td>√</td> <td>√</td> <td>X</td> </tr> </tbody> </table> <p>i NOTE: The images under PBP will be displayed at the center of the screen, not full screen.</p>	Main Window	Sub-Window			Thunderbolt 4	HDMI	DP	Thunderbolt 4	X	√	√	HDMI	√	X	√	DP	√	√	X
Main Window	Sub-Window																				
	Thunderbolt 4	HDMI	DP																		
Thunderbolt 4	X	√	√																		
HDMI	√	X	√																		
DP	√	√	X																		

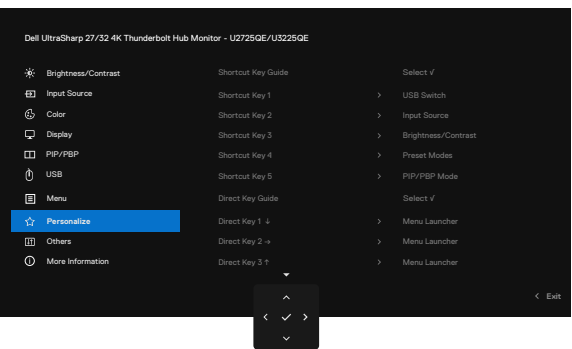
Icon	Menu and Submenus	Description
	PIP/PBP Mode	<p>Adjusts the PIP or PBP (Picture by Picture) mode. You can disable this feature by selecting Off.</p> 
	PIP/PBP (Sub)	<p>Select between the different video signals that may be connected to your monitor for the PBP sub-window. Press the the joystick button to select the PBP sub-window source signal.</p> <p>NOTE: The feature is available only when the PIP/PBP mode is enabled.</p> 
	USB Switch	<p>Select to switch between the USB upstream sources in PBP mode. Move the joystick to switch among USB upstream sources in PBP mode.</p> <p>NOTE: The feature is available only when the PIP/PBP mode is enabled.</p>
	Video Swap	<p>Select to swap videos between the main window and sub-window in PBP mode. Move the joystick to swap the main window and sub-window.</p> <p>NOTE: The feature is available only when the PIP/PBP mode is enabled.</p>
	Audio	<p>Allows you to set the audio source from the main window or the sub-window.</p> <p>NOTE: The feature is available only when the PIP/PBP mode is enabled.</p>
	Contrast (Sub)	<p>Adjust the Contrast level of the picture in PBP Mode. Move the Joystick to increase or decrease the contrast.</p> <p>NOTE: The feature is available only when the PIP/PBP mode is enabled.</p>

Icon	Menu and Submenus	Description
	USB	<p>Allows you to set the USB upstream port for the DP input signals, thus the monitor's USB downstream port (For example, keyboard and mouse) can be used by the current input signals when you connect a computer to either one of the upstream ports. When you use only one upstream port, the connected upstream port is active.</p>  <p>NOTE: To prevent data damage or loss, before changing USB upstream ports, make sure that no USB storage devices are in use by the computer connected to the monitor's USB upstream port.</p>
	DP assign to	<p>When the video signal of both DP and HDMI is connected, this option can assign the USB data of Thunderbolt or USB-C to the DP source , so that the DP source can connect to the device of the downstream port of the monitor.</p>
	HDMI assign to	<p>When the video signal of both DP and HDMI is connected, this option can assign the USB data of Thunderbolt or USB-C to the HDMI source , so that the HDMI source can connect to the device of the downstream port of the monitor.</p>
	Show KVM Setup Guide	<p>Select this option and follow steps if you want to connect multiple computers to the monitor and use one setup of keyboard and mouse.</p> <p>NOTE: HDMI input is not supported TBT output port in KVM function.</p>
	Reset USB	<p>Resets all settings under the USB menu to the factory defaults.</p>
	Menu	<p>Select this option to adjust the settings of the OSD, such as the languages of the OSD, the amount of time the menu remains on screen, and so on.</p> 
	Language	<p>Set the OSD display to one of eight languages. (English, Spanish, French, German, Brazilian Portuguese, Russian, Simplified Chinese, or Japanese).</p>
	Rotation	<p>Rotates the OSD by 0/90/270 degrees. You can press the Joystick to rotate each time.</p>
	Transparency	<p>Select this option to change the menu transparency by moving the Joystick up or down (Range: 0 - 100).</p>
	Timer	<p>OSD Hold Time: Sets the length of time the OSD remains active after you press a button. Move the Joystick to adjust the slider in 1-second increments, from 5 to 60 seconds.</p>

Icon	Menu and Submenus	Description																										
	Lock	<p>With the control buttons on the monitor locked, you can prevent people from accessing the controls. It also prevents accidental activation in multiple monitors side-by-side setup.</p>  <ul style="list-style-type: none"> • Menu Buttons: Through OSD to lock the Menu buttons. • Power Button: Through OSD to lock the Power button. • Menu + Power Buttons: Through OSD to lock the all of Menu and Power buttons. • Disable: Move the Joystick left and hold for 4 seconds. 																										
	Reset Menu	<p>Resets all settings under the Reset Menu to the factory defaults. Press the joystick to select this function.</p>																										
	Personalize	 <table border="1"> <thead> <tr> <th data-bbox="167 1288 391 1355">Shortcut Keys Guide</th> <th data-bbox="391 1288 1497 1355">Description</th> </tr> </thead> <tbody> <tr> <td data-bbox="167 1355 391 1400">Shortcut key 1</td> <td data-bbox="391 1355 1497 1400"></td> </tr> <tr> <td data-bbox="167 1400 391 1444">Shortcut key 2</td> <td data-bbox="391 1400 1497 1444">Select from Preset Modes, Brightness/Contrast, Auto Brightness, Auto Color Temp., Input Source, Aspect Ratio, Rotation, PIP/PBP Mode, USB Switch, Video Swap, Smart HDR, Display Info set as shortcut key.</td> </tr> <tr> <td data-bbox="167 1444 391 1489">Shortcut key 3</td> <td data-bbox="391 1444 1497 1489"></td> </tr> <tr> <td data-bbox="167 1489 391 1534">Shortcut key 4</td> <td data-bbox="391 1489 1497 1534"></td> </tr> <tr> <td data-bbox="167 1534 391 1579">Shortcut key 5</td> <td data-bbox="391 1534 1497 1579"></td> </tr> <tr> <th data-bbox="167 1579 391 1646">Direct Keys Guide</th> <th data-bbox="391 1579 1497 1646">Description</th> </tr> <tr> <td data-bbox="167 1646 391 1691">Direct Key 1 ↓</td> <td data-bbox="391 1646 1497 1691"></td> </tr> <tr> <td data-bbox="167 1691 391 1736">Direct Key 2 →</td> <td data-bbox="391 1691 1497 1736">Select from Menu Launcher, Preset Modes, Brightness, Contrast, Input Source, Aspect Ratio, Rotation, Display Info, PIP/PBP Mode, USB Switch, Video Swap set as Direct key.</td> </tr> <tr> <td data-bbox="167 1736 391 1780">Direct Key 3 ↑</td> <td data-bbox="391 1736 1497 1780"></td> </tr> <tr> <td data-bbox="167 1780 391 1825">Direct Key 4 ←</td> <td data-bbox="391 1780 1497 1825"></td> </tr> <tr> <td data-bbox="167 1825 391 1870">Power LED</td> <td data-bbox="391 1825 1497 1870">Allows you to set the state of the power light to save energy.</td> </tr> <tr> <td data-bbox="167 1870 391 2000">USB-C Charging (140W)</td> <td data-bbox="391 1870 1497 2000"> <p>Allows you to enable or disable USB-C Charging (140W) charging function during monitor power off mode.</p> <p> NOTE: When this function is enabled, you will be able to charge your notebook or mobile devices through the USB-C cable even when the monitor is powered off.</p> </td> </tr> </tbody> </table>	Shortcut Keys Guide	Description	Shortcut key 1		Shortcut key 2	Select from Preset Modes, Brightness/Contrast, Auto Brightness, Auto Color Temp., Input Source, Aspect Ratio, Rotation, PIP/PBP Mode, USB Switch, Video Swap, Smart HDR, Display Info set as shortcut key.	Shortcut key 3		Shortcut key 4		Shortcut key 5		Direct Keys Guide	Description	Direct Key 1 ↓		Direct Key 2 →	Select from Menu Launcher, Preset Modes, Brightness, Contrast, Input Source, Aspect Ratio, Rotation, Display Info, PIP/PBP Mode, USB Switch, Video Swap set as Direct key.	Direct Key 3 ↑		Direct Key 4 ←		Power LED	Allows you to set the state of the power light to save energy.	USB-C Charging (140W)	<p>Allows you to enable or disable USB-C Charging (140W) charging function during monitor power off mode.</p> <p> NOTE: When this function is enabled, you will be able to charge your notebook or mobile devices through the USB-C cable even when the monitor is powered off.</p>
Shortcut Keys Guide	Description																											
Shortcut key 1																												
Shortcut key 2	Select from Preset Modes, Brightness/Contrast, Auto Brightness, Auto Color Temp., Input Source, Aspect Ratio, Rotation, PIP/PBP Mode, USB Switch, Video Swap, Smart HDR, Display Info set as shortcut key.																											
Shortcut key 3																												
Shortcut key 4																												
Shortcut key 5																												
Direct Keys Guide	Description																											
Direct Key 1 ↓																												
Direct Key 2 →	Select from Menu Launcher, Preset Modes, Brightness, Contrast, Input Source, Aspect Ratio, Rotation, Display Info, PIP/PBP Mode, USB Switch, Video Swap set as Direct key.																											
Direct Key 3 ↑																												
Direct Key 4 ←																												
Power LED	Allows you to set the state of the power light to save energy.																											
USB-C Charging (140W)	<p>Allows you to enable or disable USB-C Charging (140W) charging function during monitor power off mode.</p> <p> NOTE: When this function is enabled, you will be able to charge your notebook or mobile devices through the USB-C cable even when the monitor is powered off.</p>																											

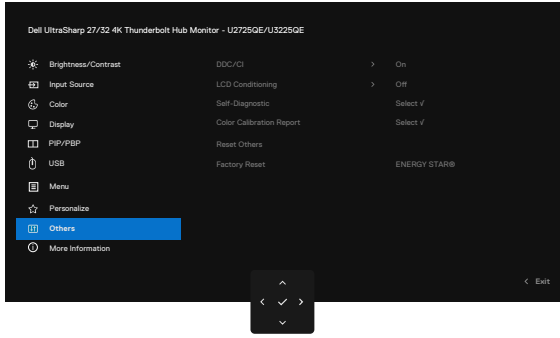
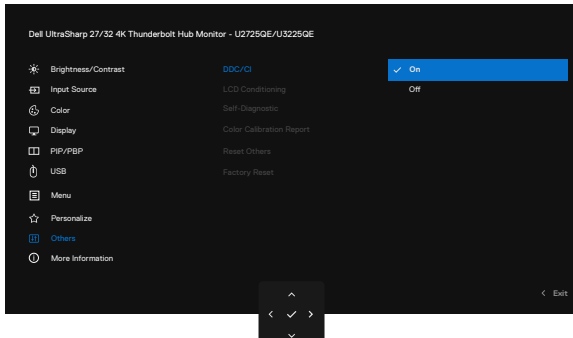
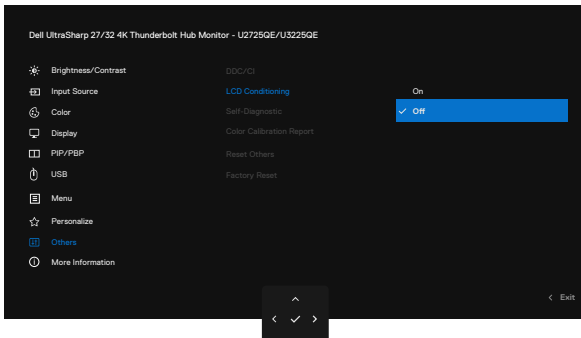
Icon	Menu and Submenus	Description
	Other USB Charging	Allows you to enable or disable Other USB Charging function during monitor Standby Mode. NOTE: When this function is enabled, you will be able to charge your mobile phone through the USB-A or USB-C cable even when the monitor is in standby mode.
	Fast Wakeup	Speed up recovery time from sleep mode.
	Reset Personalization	Resets all settings under the Personalize menu to the factory preset values. Press the joystick to select this function.
	Others	Select this option to adjust the OSD settings such as the DDC/CI, LCD Conditioning , and so on. 
	DDC/CI	DDC/CI (Display Data Channel/Command Interface) allows your monitor parameters (brightness, color balance, and etc.) to be adjustable via the software on your computer. You can disable this feature by selecting Off . Enable this feature for best user experience and optimum performance of your monitor. 
	LCD Conditioning	Helps reduce minor cases of image retention. Depending on the degree of image retention, the program may take some time to run. You can enable this feature by selecting On . 
	Self-Diagnostic	Use this option to run the built-in diagnostics, see Built-in Diagnostics .
	Color Calibration Report	Allows you to review the monitor's color data calibrated at factory product line. This includes data from four Color modes: sRGB, BT.709, DCI-P3, and Display P3. NOTE: This feature is disabled when this monitor's panel or interface board is replaced.
	Reset Others	Resets all settings under the Others menu to the factory defaults. Press the joystick to select this function.

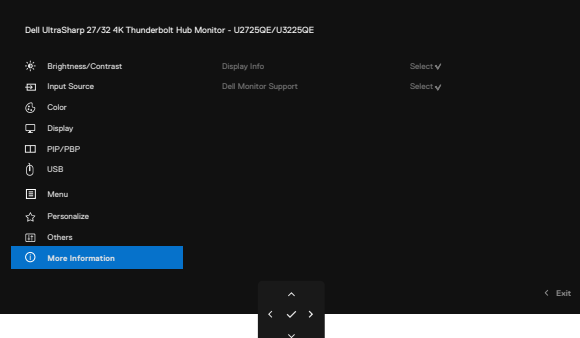
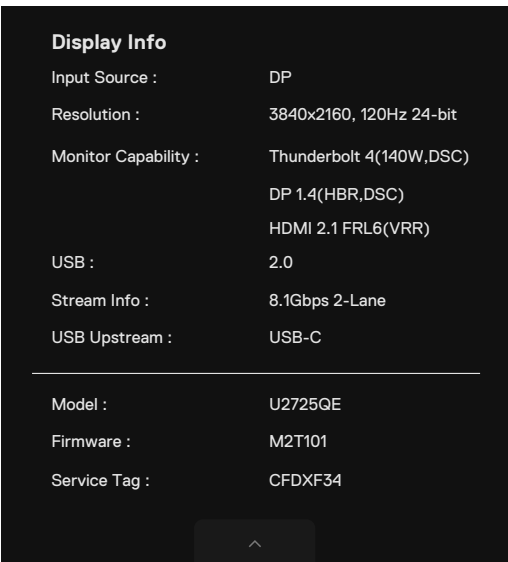
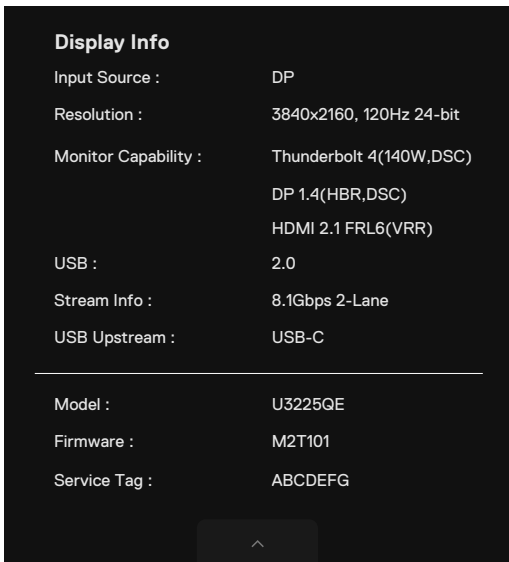
Icon	Menu and Submenus	Description
	Factory Reset	Restores all preset values to the factory default settings. These are also the settings for ENERGY STAR® tests.
	More Information	
	Display Info	<p>Displays the monitor's current settings. Press the joystick to select this function.</p> <div style="display: flex; justify-content: space-around;"> <div data-bbox="399 728 909 1288">  <p>Display Info</p> <p>Input Source : DP</p> <p>Resolution : 3840x2160, 120Hz 24-bit</p> <p>Monitor Capability : Thunderbolt 4(140W,DSC) DP 1.4(HBR,DSC) HDMI 2.1 FRL6(VRR)</p> <p>USB : 2.0</p> <p>Stream Info : 8.1Gbps 2-Lane</p> <p>USB Upstream : USB-C</p> <hr/> <p>Model : U2725QE</p> <p>Firmware : M2T101</p> <p>Service Tag : CFDXF34</p> </div> <div data-bbox="917 728 1428 1288">  <p>Display Info</p> <p>Input Source : DP</p> <p>Resolution : 3840x2160, 120Hz 24-bit</p> <p>Monitor Capability : Thunderbolt 4(140W,DSC) DP 1.4(HBR,DSC) HDMI 2.1 FRL6(VRR)</p> <p>USB : 2.0</p> <p>Stream Info : 8.1Gbps 2-Lane</p> <p>USB Upstream : USB-C</p> <hr/> <p>Model : U3225QE</p> <p>Firmware : M2T101</p> <p>Service Tag : ABCDEFG</p> </div> </div>
	Dell Monitor Support	You can scan the QR code for Dell Monitor Support.

Using the OSD lock function

You can lock the front-panel control buttons to prevent access to the OSD menu and/or power button.

Use the lock menu to lock the button(s)

1. Select one of the following options.

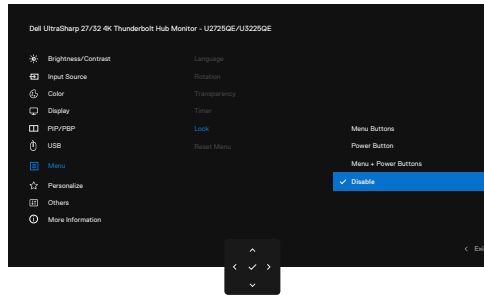

Figure 65. Select the required option to lock

The following message appears.

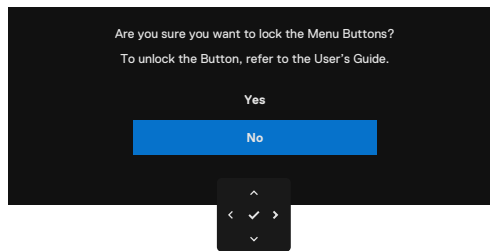



Figure 66. Lock warning message

2. Select **Yes** to lock buttons. Once locked, pressing any control button will display the lock icon .

Use the joystick to lock the button(s)

1. Press the left directional navigation of joystick for four seconds, a menu appears on the screen.

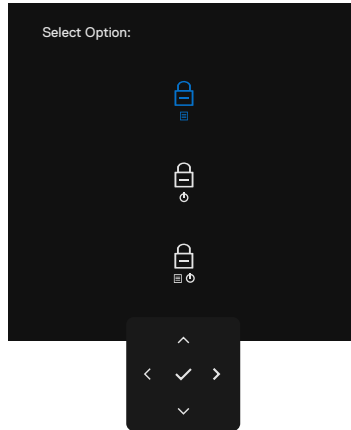





Figure 67. Lock buttons menu

2. Select one of the following options:

Table 38. Lock buttons menu description.

Options	Description
1  Menu button lock	Use this option to lock OSD menu function.
2  Power button lock	Use this option to lock power button. This will prevent the user to turn off the monitor using the power button.
3  Menu and power button lock	Use this option to lock OSD menu and power button to turn off the monitor.

Use the joystick to unlock the button(s)

Press the left directional navigation of Joystick for four seconds until a menu appears on the screen. The following table describes the options to unlock the front-panel control buttons.

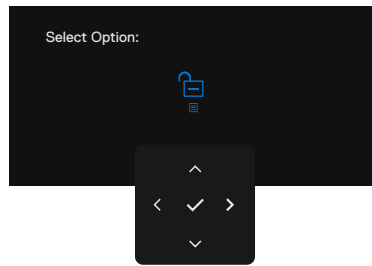





Figure 68. Unlock Menu

Table 39. Unlock menu description.

Options	Description
1  Menu button unlock	Use this option to unlock OSD menu function.
2  Power button unlock	Use this option to unlock power button to turn off the monitor.
3  Menu and power button unlock	Use this option to unlock OSD menu and power button to turn off the monitor.

Initial Setup

Select OSD items of **Factory Reset** in Other feature, the following message appears:

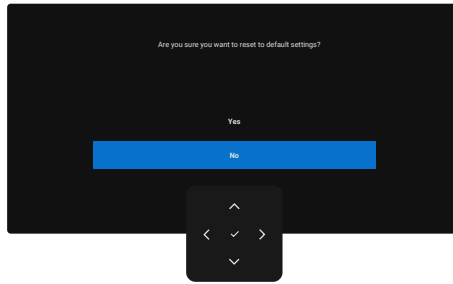

Figure 69. Reset to default settings

When you select **Yes** to reset to default settings, the following messages appear:

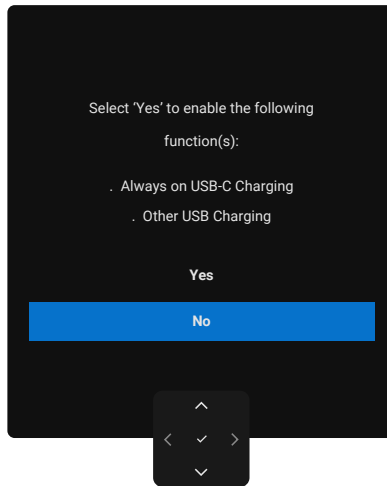

Figure 70. Reset to default settings

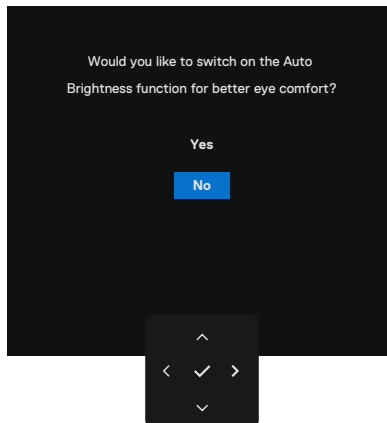

Figure 71. Auto Brightness function settings

OSD warning messages

When the monitor does not support a particular resolution mode, you can see the following message:

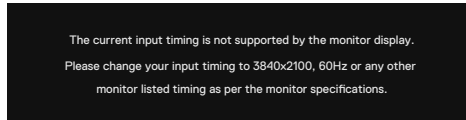

Figure 72. Does not support a particular resolution mode

This means that the monitor cannot synchronize with the signal that it is receiving from the computer. See [Monitor specifications](#) for the Horizontal and Vertical frequency ranges addressable by this monitor. Recommended mode is **3840 x 2160**.

You can see the following message before the DDC/CI function is disabled:

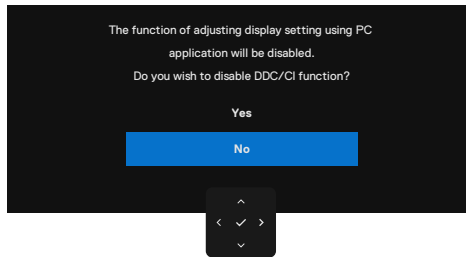

Figure 73. DDC/CI warning message

When the monitor enters the **Standby Mode**, the following message appears:

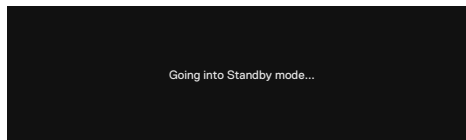

Figure 74. Standby mode warning message

Activate the computer and wake up the monitor to gain access to the **OSD**.

If you press any button other than the power button, the following messages appears depending on the selected input:

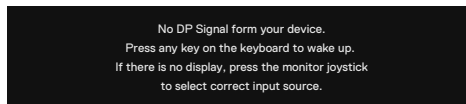

Figure 75. Warning message-wake up

A message is displayed while the cable supporting DisplayPort Alt mode is connected to the monitor under the following conditions:

- When Auto Select for **Thunderbolt (140W)** is set to **Prompt for Multiple Inputs**.
- When the Thunderbolt cable is connected to the monitor.

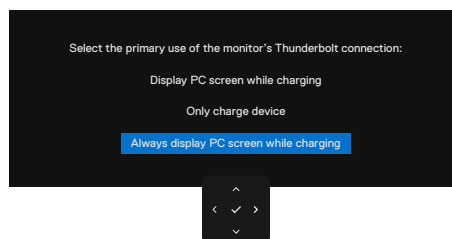

Figure 76. Warning message-Auto Select for Thunderbolt (140W)

If the monitor connects with two ports or more, when the **Auto** Input Source is selected, it will turn to the next port with signal.



Figure 77. Auto Select Input Source

Select OSD items of **On in Standby Mode** in **Personalize** feature, the following message appears:

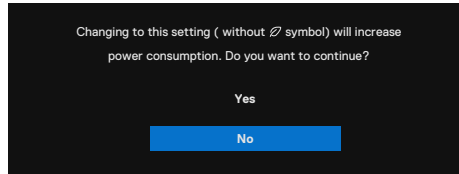

Figure 78. Warning message_Off in standby Mode

If you adjust the **Brightness** level above the default level over 75%, the following message appears:

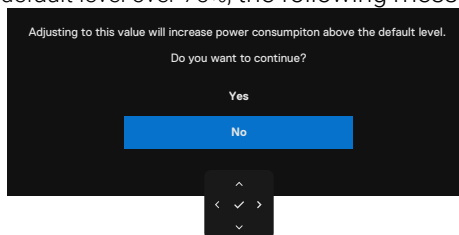

Figure 79. Warning message-Brightness level adjust

- When you select **Yes**, the power message is displayed only once.
- When you select **No**, the power warning message will pop-up again.
- The power warning message appears again only when you perform a **Factory Reset** from the OSD menu.

When **Auto Brightness** is on, if you adjust the brightness level, the following message appears:

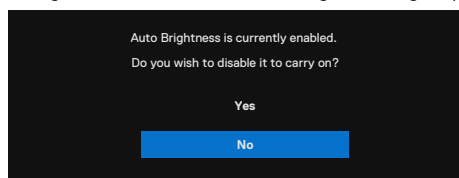

Figure 80. Warning message_Auto Brightness

If either DisplayPort, HDMI or Thunderbolt (140W) input is selected and the corresponding cable is not connected, a floating dialog box as shown below appears.

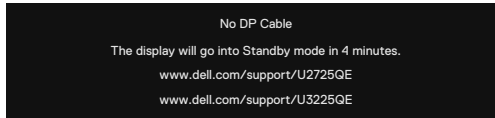

Figure 81. Warning message-no DP cable

or

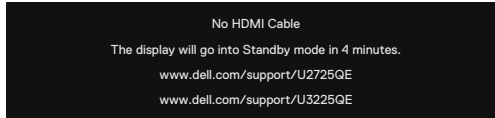

Figure 82. Warning message-no HDMI cable

or

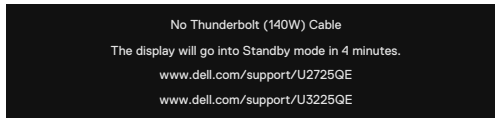

Figure 83. Warning message-no Thunderbolt(140W) cable

See [Troubleshooting](#) for more information.

Setting the maximum resolution

i NOTE: The steps may vary slightly depending on the version of Windows you have.

To set the maximum resolution for the monitor:

In Windows 10 and Windows 11:

1. Right-click the desktop and click **Display Settings**.
2. If you have more than one monitor connected, ensure that you select **U2725QE/U3225QE**.
3. Click the **Display Resolution** dropdown list and select **3840 x 2160**.
4. Click **Keep changes**.

If you do not see **3840 x 2160** as an option, you must update your graphics driver to the latest version. Depending on your computer, complete one of the following procedures:

If you have a Dell desktop or laptop:

- Go to [Dell Support Site](#), enter your service tag, and download the latest driver for your graphics card.

If you are using a non-Dell computer (laptop or desktop):

- Go to the support site for your computer and download the latest graphic drivers.
- Go to your graphics card website and download the latest graphic drivers.

Multi-Monitor Sync (MMS)

Multi-Monitor Sync allows multiple monitors that are daisy chained via DisplayPort to synchronize a pre-defined group of OSD settings in the background.

An OSD option, “Multi-Monitor Sync” is available in **Display** Menu to allow user to enable/disable syncing.

i **NOTE: MMS is not supported over HDMI interface.**

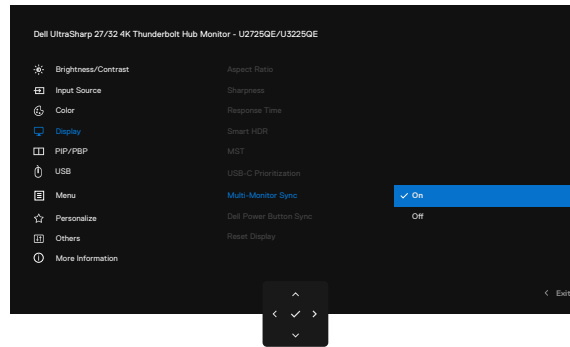

Figure 84. OSD-Display_Multi-Monitor Sync

If Monitor 2 supports Multi-Monitor Sync, its MMS option will automatically be set to **On** for syncing as well.

If syncing of OSD settings across monitors is not preferred, this feature can be disabled by setting MMS option of any of the monitor to **Off**.

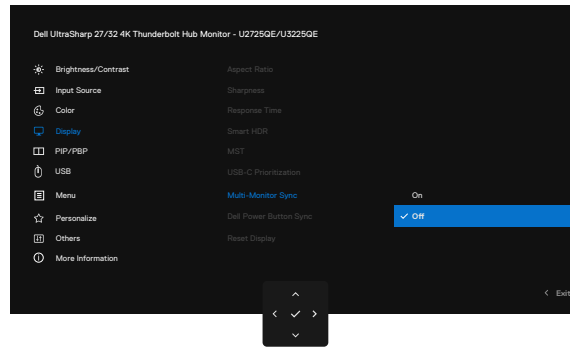

Figure 85. OSD-Display_Multi-Monitor Sync_Off

OSD Settings to be Synchronized

- Brightness
- Contrast
- Preset Modes
- Color Temperature
- Custom Color (RGB-Gain)
- Hue (Movie, Game mode)
- Saturation (Movie, Game mode)
- Response Time
- Sharpness

Setting Multi-Monitor Sync (MMS)

During initial power on or connection of new monitor, user setting synchronization starts only if MMS is **On**. All monitor should synchronize settings from Monitor 1.

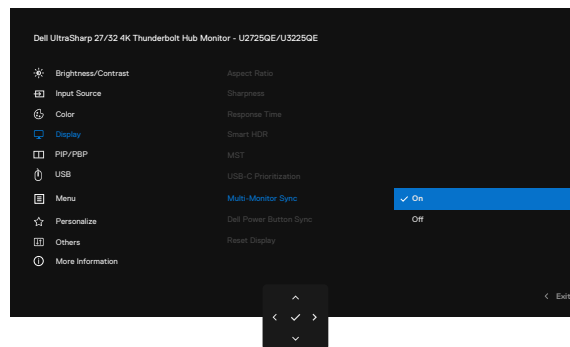

Figure 86. OSD-Display_Multi-Monitor Sync

After first synchronization, subsequent syncing is driven by changes to the predefined group of OSD settings from any node in the chain. Any node may initiate the changes downstream and upstream.

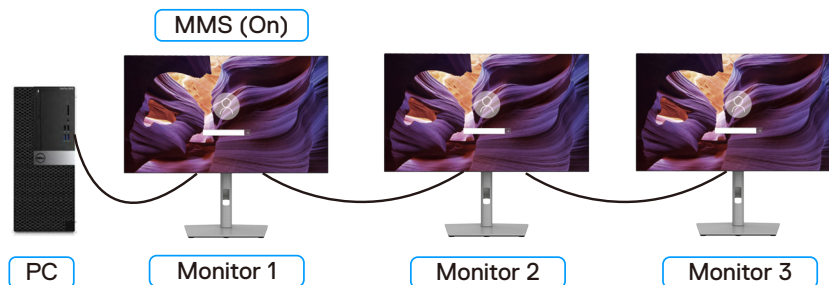

Figure 87. Multi Monitor Sync

Setting the KVM USB Switch

To set the KVM USB Switch as Shortcut Key for the monitor:

1. Press the Joystick button to launch the OSD main menu.
2. Move the Joystick to select **Personalize**.

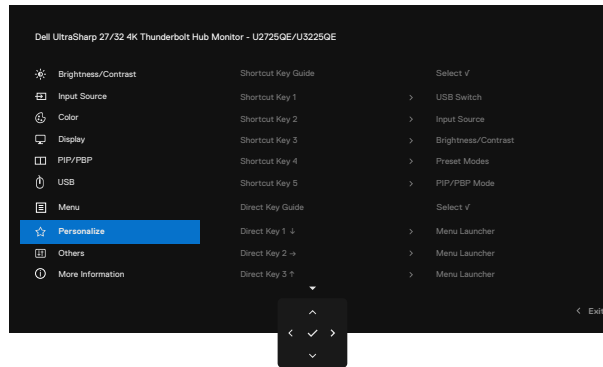

Figure 88. OSD-Personalize

3. Move the Joystick right to activate the highlighted option.
4. Move the Joystick right to activate the **Shortcut Key 1** option.
5. Move the Joystick up or down to select **USB Switch**.

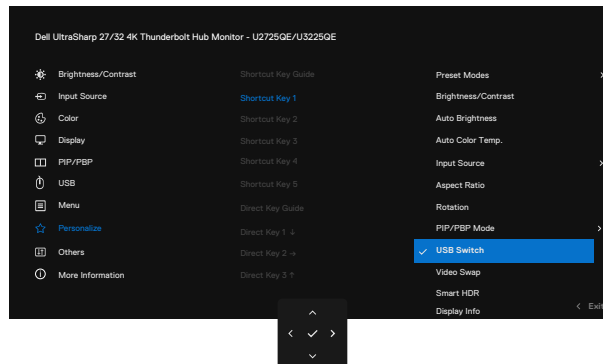

Figure 89. OSD-Personalize_Shortcut Key 1

6. Press the Joystick to confirm selection.

NOTE: KVM USB Switch function only work under PBP/PIP Mode.

The following are illustrations of several connection scenarios and their USB Selection menu settings, as illustrated in corresponding color frames.

1. When connecting **HDMI + USB Type-A to USB-C** to computer 1 and **DP + USB-C to C** to computer 2:

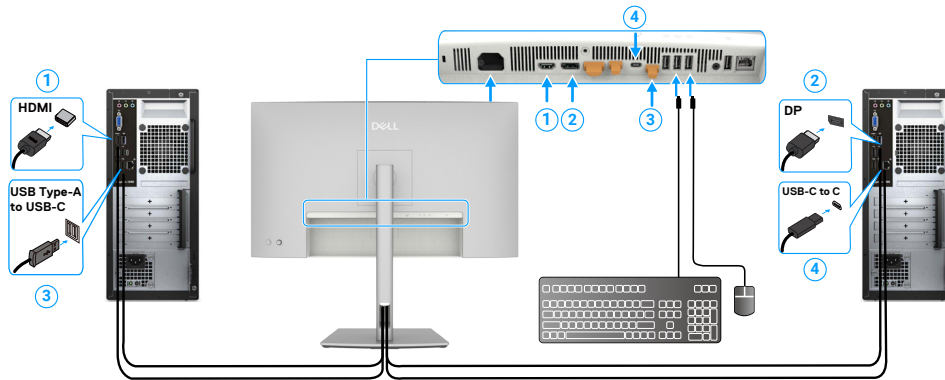

Figure 90. KVM 1 connecting

i NOTE: The USB-C connection currently supports only data transfer.

Ensure USB selection for **HDMI** is set to **USB-C** and **DP** is set to **Thunderbolt (140 W)**.

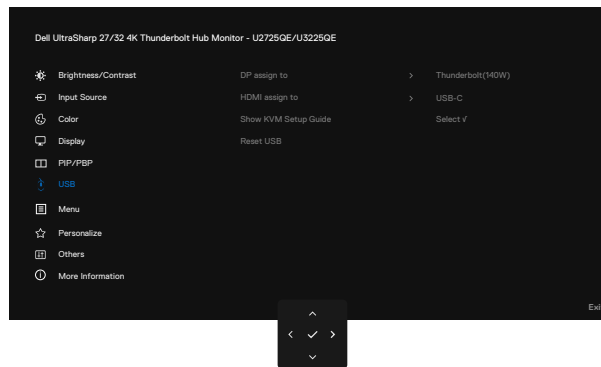

Figure 91. OSD-USB

2. When connecting **HDMI + USB Type-A to USB-C** to computer 1 and **Thunderbolt 4** to computer 2:

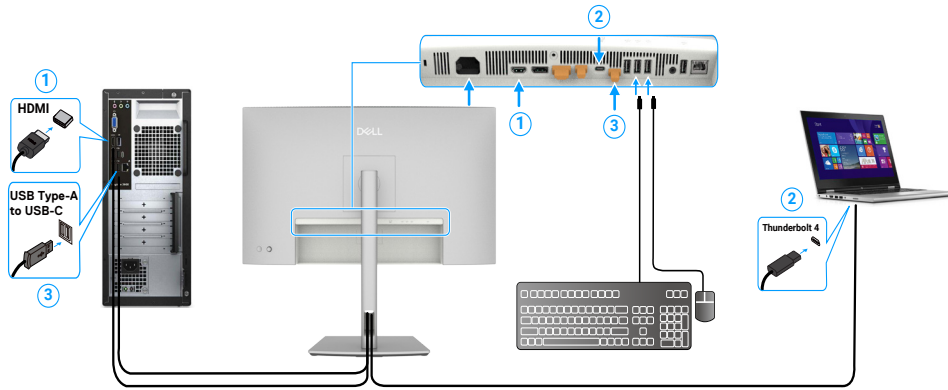

Figure 92. KVM 2 connecting

NOTE: The USB-C connection currently supports video and data transfer. Ensure **USB Selection** for **HDMI** is set to **USB-C**.

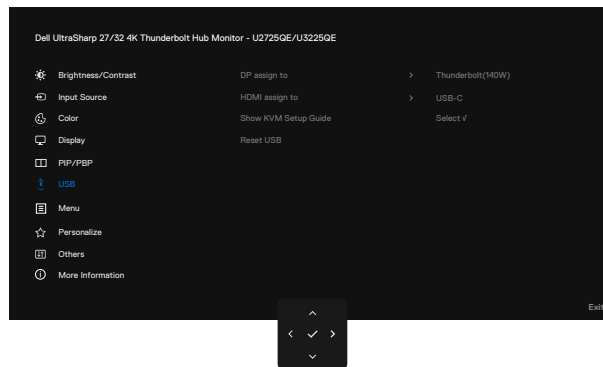

Figure 93. OSD-USB

- NOTE:** As the **Thunderbolt (140 W)** port supports the **DisplayPort Alternate Mode**, there is no need to set **USB Selection for Thunderbolt (140 W)**.
- NOTE:** When connecting to different video input sources not shown above, follow the same method to make correct settings for USB Selection to pair the ports.
- NOTE:** The built-in **KVM switch** allows you to control up to 2 computers from a single set of keyboard and mouse connected to the monitor.

Setting the Auto KVM

You can follow below instruction to set up Auto KVM for your monitor:

1. Ensure that **PBP Mode** is **Off**.

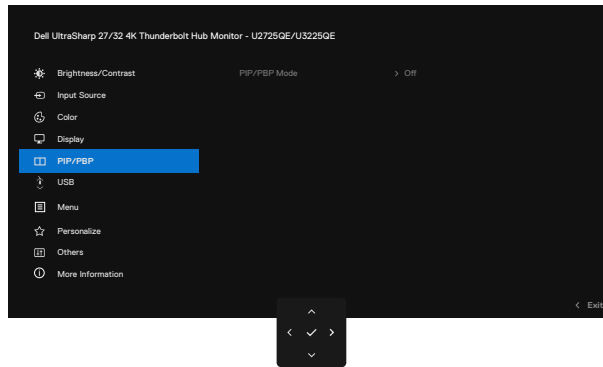

Figure 94. OSD-PIP_PBP

2. Ensure that **Auto Select** is **On** and **Auto Select for Thunderbolt** is **Yes**.

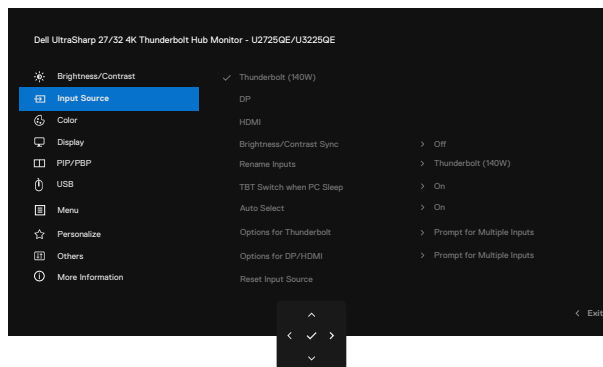

Figure 95. OSD-Input Source

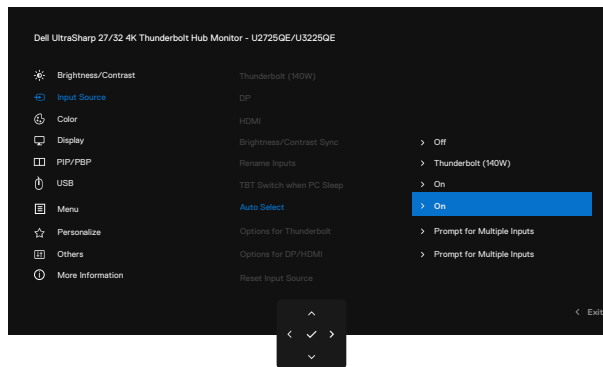

Figure 96. OSD-Input Source_Auto Select for USB-C

3. Ensure that the USB ports and the video inputs are paired accordingly.

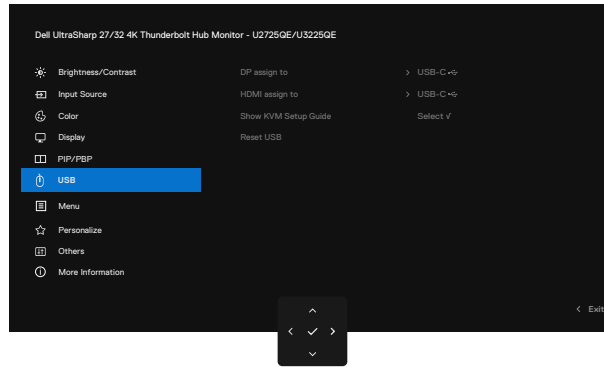

Figure 97. OSD-USB

i NOTE: For Thunderbolt connection, there is no further setting required.

Troubleshooting

⚠ WARNING: Before you begin any of the procedures in this section, follow the [Safety instructions](#).

Self-test

Your monitor provides a self-test feature that allows you to check whether your monitor is functioning properly. If your monitor and computer are properly connected but the monitor screen remains dark, run the monitor self-test by performing the following steps:

1. Turn off both your computer and the monitor.
2. Unplug the video cable from the back of the computer. To ensure proper Self-Test operation, remove all digital and the analog cables from the back of computer.
3. Turn on the monitor.

The floating dialog box should appear on-screen (against a black background), if the monitor cannot sense a video signal and is working correctly. While in self-test mode, the power LED remains white. Also, depending upon the selected input, one of the dialogs shown below will continuously scroll through the screen.

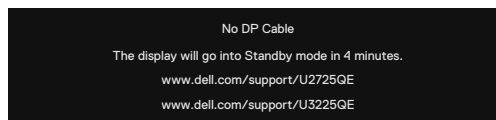

Figure 98. Warning message-no DP cable

or

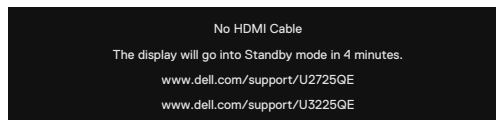

Figure 99. Warning message-no HDMI cable

or

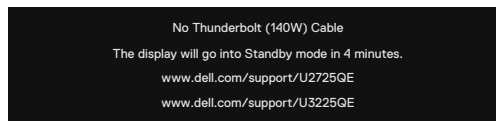

Figure 100. Warning message-no Thunderbolt (140w) cable

4. This dialog box also appears during normal operation, if the video cable is disconnected or damaged.
5. Turn off your monitor and reconnect the video cable; then turn on both your computer and the monitor.

If your monitor screen remains blank after you use the previous procedure, check your video controller and computer, because your monitor is functioning properly.

Built-in diagnostics

Your monitor has a built-in diagnostic tool that helps you determine if the screen abnormality you are experiencing is an inherent problem with your monitor, or with your computer and video card.

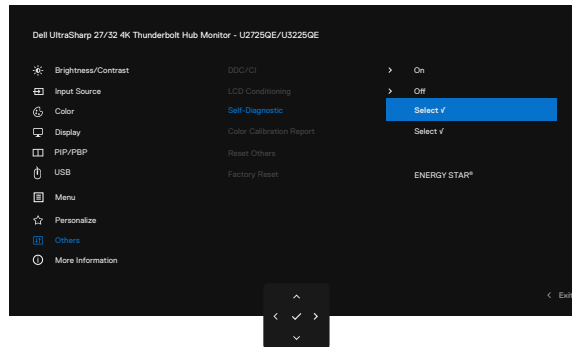

Figure 101. OSD-Others_Self-Diagnostic

To run the built-in diagnostics:

1. Ensure that the screen is clean (no dust particles on the surface of the screen).
2. Select OSD items of **Self-Diagnostics** in **Others** feature.
3. Press the Joystick button to start the diagnostics. A gray screen is displayed.
4. Observe if the screen has any defects or abnormalities.
5. Toggle the Joystick once again until a red screen is displayed.
6. Observe if the screen has any defects or abnormalities.
7. Repeat steps 5 and 6 until the screen displays green, blue, black, and white colors. Note any abnormalities or defects.

The test is complete when a text screen is displayed. To exit, toggle the Joystick control again.

If you do not detect any screen abnormalities upon using the built-in diagnostic tool, the monitor is functioning properly. Check the video card and computer.

Common problems

The following table contains general information about common monitor problems you might encounter and the possible solutions:

⚠ WARNING: The monitor LCD panel duty cycle is designed for 18 hours a day, 7 days a week. Usage higher than the designed duty cycle may result in premature decrease in panel backlight luminance, which may not be covered under warranty.

Table 40. Common problems

Common symptoms	What you experience	Possible solutions
No Video/Power LED off	No picture	<ul style="list-style-type: none"> Ensure that the video cable connecting the monitor and the computer is properly connected and secure. Verify that the power outlet is functioning properly using any other electrical equipment. Ensure that you have pressed the power button properly. Ensure that the correct input source is selected in the Input Source menu.
No video/Power LED on	No picture or no brightness	<ul style="list-style-type: none"> Increase brightness and contrast controls through OSD. Perform monitor self-test feature check. Check for bent or broken pins in the video cable connector. Run the built-in diagnostics, For more information, see Self-Diagnostic. Ensure that the correct input source is selected in the Input Source menu.
Missing pixels	LCD screen has spots	<ul style="list-style-type: none"> Cycle power on-off. Pixel that is permanently off is a natural defect that can occur in LCD technology. For more information on Dell Monitor Quality and Pixel Policy, see www.dell.com/pixelguidelines
Stuck-on pixels	LCD screen has bright spots	<ul style="list-style-type: none"> Cycle power On-Off. Pixel that is permanently off is a natural defect that can occur in LCD technology. For more information on Dell Monitor Quality and Pixel Policy, see www.dell.com/pixelguidelines
Brightness problems	Picture too dim or too bright	<ul style="list-style-type: none"> Reset the monitor to factory settings. Adjust brightness and contrast controls through OSD.
Safety related issues	Visible signs of smoke or sparks	<ul style="list-style-type: none"> Do not perform any troubleshooting steps. Contact Dell immediately.
Intermittent problems	Monitor malfunctions on and off	<ul style="list-style-type: none"> Ensure that the video cable connecting the monitor to the computer is connected properly and is secure. Reset the monitor to factory settings. Perform monitor self-test feature check to determine if the intermittent problem occurs in self-test mode.
Missing color	Picture missing color	<ul style="list-style-type: none"> Perform monitor self-test. Ensure that the video cable connecting the monitor to the computer is connected properly and is secure. Check for bent or broken pins in the video cable connector.
Wrong color	Picture color not good	<ul style="list-style-type: none"> Try different Preset Modes in Color settings OSD. Adjust R/G/B value under Custom Color in Color menu OSD. Change the Input Color Format to RGB or YCbCr in the Color settings OSD. Run the built-in diagnostics.
Image retention from a static image left on the monitor for a long period of time	Faint shadow from the static image displayed appears on the screen	<ul style="list-style-type: none"> Set the screen to turn off after a few minutes of screen idle time. These can be adjusted in Windows Power Options or Mac Energy Saver setting. Alternatively, use a dynamically changing screensaver.

Product-specific problems

Table 41. Product-specific problems

Specific symptoms	What you experience	Possible solutions
The screen image is too small	Image is centered on screen, but does not fill entire viewing area	<ul style="list-style-type: none"> Check the Aspect Ratio setting in the Display menu OSD. Reset the display to factory settings.
Cannot adjust the monitor with the joystick control on the rear of the monitor	OSD does not appear on the screen	<ul style="list-style-type: none"> Turn off the monitor, unplug the monitor power cable, plug it back, and then turn on the monitor. Check whether the OSD menu is locked. If yes, move and hold the joystick forward/back/left/right for 4 seconds to unlock.
No input signal when user controls are pressed	No picture, the LED light is white	<ul style="list-style-type: none"> Check the signal source. Ensure that the computer is not in the power saving mode by moving the mouse or pressing any key on the keyboard. Check whether the signal cable is plugged in properly. Connect the signal cable again, if necessary. Reset the computer or video player.
The picture does not fill the entire screen	The picture cannot fill the height or width of the screen	<ul style="list-style-type: none"> Due to different video formats (aspect ratio) of DVDs, the monitor may display in full screen. Run the built-in diagnostics.
No image when using DP connection to the PC	Black screen	<ul style="list-style-type: none"> Verify which DP standard (DP 1.1a or DP 1.4) is your Graphics Card certified to. Download and install the latest graphics card driver. Some DP 1.1a graphics card cannot support DP 1.4 monitors.
No image when using Thunderbolt 4 connection to computer, laptop, and so on	Black screen	<ul style="list-style-type: none"> Verify if the Thunderbolt 4 interface of the device can support DP alternate mode. Verify if the device required more than 140 W power charging. Thunderbolt 4 interface of device cannot support DP alternate mode. Set Windows to Projection mode. Ensure that the Thunderbolt 4 cable is not damaged.
No charging when using Thunderbolt 4 connection to computer, laptop, and so on	No charging	<ul style="list-style-type: none"> Verify if the device can support one of 5 V / 9 V / 15 V / 20 V / 28 V charging profiles. Verify if the Notebook requires a >140 W power adaptor. If the Notebook requires a >140 W power adaptor, it may not charge with the Thunderbolt 4 connection. Ensure that you use only Dell approved adapter or the adapter that comes with the product. Ensure that the Thunderbolt 4 cable is not damaged.
Intermittent charging when using Thunderbolt 4 connection to computer, laptop, and so on	Intermittent charging	<ul style="list-style-type: none"> Check if the maximum power consumption of device is over 140 W. Ensure that you use only Dell approved adapter or the adapter that comes with the product. Ensure that the Thunderbolt 4 cable is not damaged.
Thunderbolt 4 source MST connect two monitors, there is no signal on one of the monitors.	One of the monitors no signal	<ul style="list-style-type: none"> Please use the original Thunderbolt 4 cable in the box to connect two monitors.
Thunderbolt 4 source MST connect two monitors, the two monitors cannot be selected to 3840 x 2160 120 Hz at the same time.	Resolution can't select 3840 x 2160 120 Hz	<ul style="list-style-type: none"> Ensure your cable is original Thunderbolt 4 cable in the box. Open monitor menu, select to Display, confirm MST is On or Off? If on, please help confirm the monitor MST is Off.
Ethernet port (RJ45) cannot connect to internet	Ethernet port (RJ45) cannot connect to internet on Win 10 / Win 11	<ul style="list-style-type: none"> Change the LAN Controller Power Saving from Enable to Disable

Specific symptoms	What you experience	Possible solutions
The LAN port is not functioning	OS setting or cable connection issue	<ul style="list-style-type: none"> • Ensure that the latest BIOS and drivers for your computer are installed on your computer. • Ensure that the RealTek 2.5 G Ethernet Controller is installed in the Windows Device Manager. • If your BIOS Setup has a LAN/GBE Enabled/ Disabled option, make sure it is set to Enabled. • Ensure that the Ethernet cable is connected securely on the monitor and the hub/router/ firewall. • Check the status LED of the Ethernet cable to confirm connectivity. Re-connect both ends of the Ethernet cable if the LED is not lit. • First power off the Computer and unplug the Thunderbolt 4 cable and power cord of the monitor. Then, power on the computer, plug in the monitor power cord and Thunderbolt 4 cable.
Ambient light detection abnormally.	When Auto Brightness is on, the detected ambient light drops significantly	<ul style="list-style-type: none"> • Check whether an object is obstructing the sensor area. • Ensure a webcam is not mounted over the sensor area. • Wipe clean any dust that may be covering the sensor area. • Ensure the display is not pivoted and placed to another monitor side-by-side.

Universal Serial Bus (USB) specific problems

Table 42. Universal Serial Bus (USB) specific problems

Specific symptoms	What you experience	Possible solutions
USB interface is not working	USB peripherals are not working	<ul style="list-style-type: none"> • Check that your display is turned ON. • Reconnect the upstream cable to your computer. • Reconnect the USB peripherals (downstream connector). • Switch off and then turn on the display again. • Reboot the computer. • Some USB devices like external portable HDD require higher electric current; connect the device directly to the computer system.
SuperSpeed USB 3.2 interface is slow	SuperSpeed USB 3.2 peripherals working slowly or not working at all	<ul style="list-style-type: none"> • Check that your computer is USB 3.2-capable. • Some computers have USB 3.1, USB 3.0, USB 2.0, and USB 1.1 ports. Ensure that the correct USB port is used. • Reconnect the upstream cable to your computer. • Reconnect the USB peripherals (downstream connector). • Reboot the computer.
Wireless USB peripherals stop working when a USB 3.2 device is plugged in	Wireless USB peripherals responding slowly or only working as the distance between itself and its receiver decreases	<ul style="list-style-type: none"> • Increase the distance between the USB 3.2 peripherals and the wireless USB receiver. • Position your wireless USB receiver as close as possible to the wireless USB peripherals. • Use a USB-extender cable to position the wireless USB receiver as far away as possible from the USB 3.2 port.
USB is not working	No USB functionalities	<ul style="list-style-type: none"> • See the input source and USB pairing table.

Regulatory information

TCO Certified

Any Dell product bearing a TCO label has been certified to a TCO voluntary environmental certification. TCO certification requirements focus on features that contribute to a healthy work environment such as recyclable design, energy efficiency, ergonomics, emissions, avoidance of hazardous substances, and product take back.

For more information on your Dell product and the TCO certification, please visit: Dell.com/environment/TCO_Certified.

For more information on TCO's environmental certifications, please visit: tcocertified.com.

FCC notices (U.S. only) and other regulatory information

For FCC notices and other regulatory information, see the regulatory compliance website at [Dell Regulatory Compliance Home Page](#).

EU product database for energy label and product information sheet

U2725QE: <https://eprel.ec.europa.eu/qr/2166050>

U3225QE: <https://eprel.ec.europa.eu/qr/2166053>

Contacting Dell

To contact Dell for sales, technical support, or customer service issues, see [Contact Support at Dell Support Site](#).

i NOTE: Availability varies by country and product, and some services may not be available in your country.

i NOTE: If you do not have an active Internet connection, you can find contact information about your purchase invoice, packing slip, bill, or Dell product catalog.